

MYTECH

TECHNOLOGY FOR DREAMERS

Avevamo già in mente ciò che volevamo realizzare con Mytech.

Non desideravamo produrre semplici bauletti per moto ma realizzare i nostri sogni da motociclisti.

Siamo fortemente convinti che non esista soddisfazione più grande che vedere moto equipaggiate con i propri prodotti, pronte per macinare km e km di strada.

Studiamo, progettiamo e realizziamo le valigie come se dovessimo equipaggiare le nostre moto.

Vogliamo realizzare il meglio senza compromessi.

Questa è una sfida continua.

We already had in mind what we wanted to achieve with Mytech.

We did not want to produce simple cases for motorcycles but make our motorcycle dreams come true. We are strongly convinced that there is no greater satisfaction than seeing motorcycles equipped with their own products, ready to grind miles and miles of road.

We study, design and manufacture motorcycle suitcases as if we were to equip our motorcycles.

We want to achieve the best without overcoming.

This is an ongoing challenge.



INDICE



06 /	MYTECH	<i>Mytech</i>
08 /	LINEE VALIGIE	<i>Suitcases</i>
46 /	VALIGIE LATERALI	<i>Side cases</i>
116 /	TOP CASE	<i>Top cases</i>
170 /	BORSE MORBIDE	<i>Soft Bags</i>
182 /	ACCESSORI	<i>Accessories</i>
196 /	PROTEZIONI	<i>Protections</i>
224 /	ESPOSITORI	<i>Display</i>

PASSIONE E MOTO

Passion and bike

In Mytech viviamo la passione per la moto e per il lavoro come un'unica cosa. Tutti noi sappiamo che non stiamo producendo una semplice valigia, perchè quella sarà compagna di viaggio per migliaia di km e quindi dev' essere perfetta. Ci piace sognare insieme a voi, ci piace vedervi partire con le valigie vuote e tornare pieni di avventure e sogni realizzati. Perchè noi siamo motociclisti come i nostri clienti.

At Mytech we live the passion for motorcycles and for work as one thing. We all know that we are not producing a simple suitcase, because that will be a travel companion for thousands of km and therefore must be perfect. We like to dream with you, we like to see you leave with empty suitcases and come back with adventures and dreams come true. Because we are motorcyclists like our customers.



L'AZIENDA

The company

Il nostro gruppo ha alle spalle 60 anni di storia: 60 anni di esperienza e di know how cresciuto sempre di più per poter sviluppare prodotti all'avanguardia. Occupiamo 9000 mq. di superficie in Italia dove produciamo tutti i nostri prodotti. Qui viene seguita tutta la filiera produttiva, dalla R&D, al design, alle analisi di fattibilità e test, fino alla commercializzazione. Collaboriamo con brand come Moto Guzzi, Aprilia, MV Augusta e Piaggio per il primo equipaggiamento di serie. Produciamo e forniamo anche altri componenti motociclistici.

Our group has 60 years of history behind it: 60 years of experience and know-how that has grown more and more in order to develop cutting-edge products. We occupy 9000 square meters. of surface area in Italy where we produce all our products. Here the entire production chain is followed, from R&D, to design, to feasibility analyzes and tests, up to marketing. We collaborate with brands such as Moto Guzzi, Aprilia, MV Augusta and Piaggio for original standard equipment. We also manufacture and supply other motorcycle components.



LINEE VALIGIE

Our Mytech Panniers

10 / RAID PRO

14 / SOFT - X

18 / SUPERLEGGERA

22 / MODEL - X

26 / MODEL - X RAW

30 / MODEL - X GSA

34 / RAID

38 / RAID GSA

42 / SMART TANK



RAID PRO



waterproof



lock system



aluminum



easy fix



sliding

La nuova generazione di valigie in alluminio RAID PRO, prodotte in Italia. Una nuova linea con un design più accattivante che mantiene impermeabilità, robustezza e resistenza alle sollecitazioni.

The new generation of RAID PRO aluminum suitcases, produced in Italy. A new line with a more attractive design while maintaining waterproofness, robustness and resistance to stress.



A NEW RAID VERSION

A 10 years long evolution

UN'EVOLUZIONE LUNGA 10 ANNI



RAID PRO

● Painted or raw Aluminum



aluminum

La nuova generazione di valigie in alluminio Raid Pro, interamente prodotte in Italia. La nuova Raid Pro avrà un design più accattivante, leggerezza mantenendo comunque i tre pilastri importanti: impermeabilità assoluta, robustezza e resistenza alle sollecitazioni, tutto questo per garantire il massimo delle prestazioni su moto Adventure e maxi-enduro.

The new generation of Raid Pro aluminum suitcases, produced in Italy. The new line will have a more attractive design, lightness while maintaining the three important pillars: absolute waterproofness, robustness and resistance to stress, all this to guarantee maximum performance on Adventure and maxi-enduro motorbikes.



Finitura in alluminio naturale o verniciato nero. Disponibili due dimensioni differenti. Entrambe con angolari neri.

Natural or black painted aluminum finish. Two different sizes available. Both with black corners.

Sgancio: nuovo sistema "SlidingSystem" dotato di staffa scorrevole e manopole interne a vite per bloccaggio.

Release: new "SlidingSystem" system equipped with sliding bracket and internal screw knobs for locking.



sliding

Utile per appendere il tuo casco.
Useful for hanging your helmet.



[Pag 82 Raid Pro Laterali](#)
[Pag 82 Raid Pro Side suitcase](#)

[Pag 152 Raid Pro Bauletto](#)
[Pag 152 Raid Pro Top case](#)

SOFT-X BORSE MORBIDE



waterproof



lock system



pes



tpu



aluminum



quick release

Una linea di valigie morbide studiate con gli stessi criteri delle valigie in alluminio: massima qualità, massima affidabilità e massima resistenza senza nessun compromesso.

A line of soft bags designed with the same criteria as aluminum cases: maximum quality, maximum reliability and maximum resistance without compromises.

Materiale:
80% Polyester e 20% TPU, con spessore di 0.48mm

Material:
80% Polyester and 20% TPU, with a thickness of 0.48mm



SOFT BAGS

Push Block System

ATTACCO PUSH BLOCH

È possibile acquistare la versione con la piastra, dotata di sistema Push Block per essere applicate ai nostri telaietti Mytech.

It is possible to purchase the version with the plate, equipped with the Push Block system to be applied to our Mytech frames.



SOFT X BORSE MORBIDE

Painted Aluminum

Realizzate in Poliestere e TPU. Le Valigie sono universali. Le Valigie laterali per essere agganciate necessitano della piastra Soft-x con Push Block Mytech. Il borsone 60Lt può essere riposto sulla piastra portatutto e agganciata con dei cavi.

Made of Polyester and TPU. The suitcases are universal. The side cases require the Soft-x plate with Push Block Mytech to be attached. The 60Lt bag can be stored on the roof plate and attached with cables.



Materiale estremamente leggero.
Spessore: 0.48mm
Volume: 60Lt e 34Lt

*Extremely Light material.
Thickness: 0.48mm
Volume: 60Lt or 34Lt*



aluminum

Maniglia in alluminio marcata Mytech per migliorare la presa della borsa.

Mytech branded aluminum handle to improve the grip of the bag.



Borsa ad alta tenuta d'acqua. Ganci e componentistica in alluminio ad alta resistenza.

Highly watertight bag. High resistance aluminum hooks and components.



pes

Accessori: borsa porta pc imbottita ed estraibile, tasche esterne in rete, attacco di sicurezza con combinazione, tracolla rimovibile, maniglia di trasporto, attacchi per carichi esterni.

Accessories: removable padded laptop bag, external mesh pockets, combination safety attachment, removable shoulder strap, carrying handle, attachments for external loads.



tpu

Chiusura a rotolo della borsa. Possibilità di riporre oggetti extra nelle apposite retine laterali.

Roll closure of the bag. Possibility of storing extra items in the special side nets.



[Pag 88 Soft-x Side Bags](#)
[Pag 88 Soft-x Side Bags](#)

[Pag 180 Soft-x Top Bag](#)
[Pag 180 Soft-x Top Bag](#)

Superleggera



waterproof



lock system



aluminum



carbon



push block



superlight

Il meglio senza compromessi:
carbonio e alluminio per un'innovazione assoluta
nel campo delle valigie da viaggio per moto.

*Undoubtedly the best!
Carbon + aluminum for an stunning innovation
in travel suitcases for motorcycles.*

I motociclisti veri, quelli che usano le valigie per centinaia di migliaia di km in
lunghi ed impegnativi viaggi sono il nostro riferimento. Cosa ci chiedono?
Valigie più leggere a parità di prestazioni. Senza Compromessi.

*Real motorcyclists, those who use suitcases for hundreds of thousands of
kilometers on long and challenging journeys are our reference. What do they
ask of us? Lighter suitcases with the same performance. No Compromise.*



-44%

LightEST BAGGAGE

VALIGIE PIÙ LEGGERE DEL 44%

Ecco perché Superleggera. Anni di studi e ricerche per
raggiungere il 44% in meno di peso. Con prestazioni senza
compromessi.

*This is why Superleggera. Years of study and research to
accomplish 44% less weight. With even higher performance
than the Top of the market.*



Superleggera

Aluminum and Carbon

Carbonio e alluminio accoppiati per identificare un segmento di mercato ancora al di sopra di quelle considerate Top Premium. E' l'accoppiamento perfetto per unire leggerezza e rigidità, estrema resistenza e durata, con prestazioni meccaniche senza compromessi. Il nuovo paradigma del viaggio in moto.

Carbon and aluminum coupled to identify a market segment still above those considered Top Premium. It is the perfect match to combine Lightness and stiffness, extreme strength and durability, with uncompromising mechanical performance. The new paradigm of motorcycle travel.

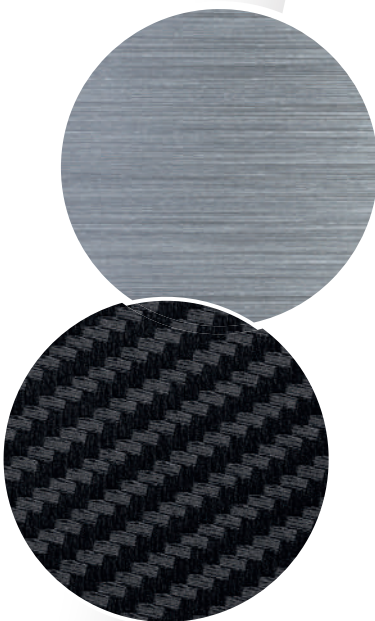

carbon

Fibra di carbonio a tre strati con orientamento in trasversale a 45°, sovrapposti, per orientare più filamenti lungo le linee di sollecitazione. Verniciatura di protezione UV trasparente extra opaca graduabile.

Overlapping three-layer carbon fiber with 45° transversal orientation to guide more filaments along the stress lines. Graduable extra opaque transparent UV protection coating.



aluminum

Rinforzi in lega di alluminio-magnesio appositamente disegnati e modellati per incrementare le caratteristiche meccaniche e la resistenza agli urti della valigia. Finitura naturale spazzolata.

Reinforcements in aluminum magnesium alloy specifically designed and molded to reinforce the mechanical characteristics and impact resistance of the suitcase. Natural brushed finish.



waterproof

Profilo: guarnizione in gomma annegata all'interno del profilo in carbonio con impermeabilità al 100 % in qualunque condizione e sollecitazione, grazie alla totale rigidità.

Profile: rubber gasket embedded inside the carbon profile with 100% waterproofing in any condition and stress due to the total rigidity of the frame.



lock system

Componentistica e fissaggi: acciaio inox austenitico amagnetico spessore 2 mm. Sgancio rapido: tramite Push Block.

Components & fixings: 2 mm thick non-magnetic austenitic stainless steel. Quick release: takes place via Push Block.



push block

Chiusura di sicurezza: SecurityLock System.

Security lock: SecurityLock System.

[Pag 52 Superleggera Laterali](#)
[Pag 52 Superleggera Side suitcase](#)

[Pag 120 Superleggera Bauletto](#)
[Pag 120 Superleggera Top case](#)



MODEL - X



waterproof lock system aluminum push block customize quick release

*La linea Model-x ti permette un look più aggressivo abbinabile al colore della tua moto.
Un vantaggio ulteriore è che gli angolari sono sostituibili: quando vorrai cambiare moto, ti basterà cambiare il colore degli angolari.*

*The Model-x line allows you a more aggressive look combinable with the color of your bike.
An additional advantage is that the corners are replaceable: when you want to change bikes, just change the color of the corners.*



CUSTOMIZE

YOUR Model-x
LA TUA MODEL-X



MODEL - X

Painted Aluminum



aluminum

La linea di valigie più performanti e completa sul mercato. Realizzata completamente in alluminio verniciato, disponibile in finitura nera o grigia con angolari personalizzabili, a doppia guarnizione. Il fondo ed il coperchio sono stampati ed imbutiti in un pezzo unico. Il corpo è fissato con ribattini in alluminio per renderlo perfettamente a tenuta d'acqua. Le valigie grazie alla verniciatura hanno un'elevata tenuta agli eventi atmosferici e urti.

The most performing and complete line of suitcases on the market. Made entirely of painted aluminum, available in black or grey finish with customizable corners, with double gasket. The bottom and the lid are molded and drawn in a single piece. The body is fixed with aluminum rivets to make it waterproof. The cases are anodized to give greater resistance to atmospheric events and shocks.



Grey



Black

Utile per appendere il tuo casco.
Useful for hanging your helmet.



Corners available colors



customize

Disponibile in due misure, grande e piccola.
Personalizzazione: gli angolari da applicare sulla valigia possono essere scelti tra nero, arancione, rosso e blu.

*Available in two sizes, large and small.
Customization: the corners to be applied on the suitcase can be chosen from black, orange, red and blue.*



push block

Sgancio rapido: il fissaggio avviene tramite sgancio rapido con Push Block e necessita del telaio Mytech per il fissaggio.

Quick release: fixing takes place via quick release with Push Block and requires the Mytech frame for fixing.

[Pag 56 Model-x Laterali](#)
[Pag 56 Model-x Side suitcase](#)

[Pag 124 Model-x Bauletto](#)
[Pag 124 Model-x Top case](#)

MODEL - X RAW



waterproof



lock system



raw alu



push block



quick release

Model-x Raw, una versione senza filtri per esaltare le qualità dell'alluminio, delle lavorazioni e del prodotto artigianale. Realizzata interamente in alluminio grezzo, con sgancio rapido.

Model-x Raw, a version without filters to enhance the quality of aluminum, processing and product artisanal. Made entirely of raw aluminum, with quick release.



La linea di valigie Model-x Raw può essere customizzata come vuoi tu con un wrapping high tech. Contattare il servizio clienti per definire la texture o il vostro progetto personalizzato, alla mail customer@mytechaccessories.it

The Model-x Raw line of suitcases can be customized however you want with a high tech wrapping. Contact customer service to define the texture or your custom project at customer@mytechaccessories.it



RAW VERSION

Raw aluminum

ALLUMINIO GREZZO



MODEL - X RAW

Raw Aluminum

Realizzata in alluminio grezzo, senza verniciatura ed angolari rispetto alla classica Model-x. Il fondo e il coperchio vengono stampati ed imbutiti in un pezzo unico, il corpo è fissato con ribattini per rendendolo perfettamente a tenuta d'acqua.

Made of raw aluminum, unpainted and angular compared to the classic Model-x. The bottom and lid are molded and drawn in a single piece, the body is fixed with rivets to make it waterproof.



Raw

Utile per appendere il tuo casco.
Useful for hanging your helmet.



aluminum

Disponibile in due misure grande e piccola, senza angolari.

Available in two sizes large and small, without corner pieces.



push block

Sgancio rapido: il fissaggio avviene tramite sgancio rapido con Push Block e necessita del telaio Mytech per il fissaggio.

Quick release: fixing takes place via quick release with Push Block and requires the Mytech frame for fixing.



[Pag 74 Model-x RAW Laterali](#)
[Pag 74 Model-x RAW Side suitcase](#)

[Pag 142 Model-x RAW Bauletto](#)
[Pag 142 Model-x RAW Top case](#)



MODEL - X GSA



waterproof



lock system



raw alu



push block



attacks



quick release

Modello specifico per BMW GS ADVENTURE, monta direttamente sui telai originali. Disponibile a sgancio rapido in due colorazioni: alluminio grezzo e nero.

Specific model for BMW GS ADVENTURE, mounts directly on the original frames. Available with quick release in two colors: raw aluminum and black.



FOR ORIGINAL FRAME

BMW GS ADVENTURE

PER TELAIO ORIGINALE BMW

MODEL - X GSA

Raw and painted Aluminum

Realizzata interamente in alluminio, compreso il profilo. Disponibile con finitura nera o grezza con angolari neri. Il profilo è in alluminio con doppia guarnizione per renderlo perfettamente a tenuta d'acqua. Il fondo ed il coperchio vengono stampati ed imbutiti in un pezzo unico, il corpo è fissato con ribattini per la completa impermeabilità.

Made entirely of aluminum, including the profile. Available in black or raw finish with black corners. The profile is made of aluminum with double gasket to make it waterproof. The bottom and the lid are molded and drawn in a single piece, the body is fixed with rivets for complete waterproofing.



raw alu

Top case 44 lt, valigie 41-47 lt. Tutte le versioni prevedono gli angolari neri.

Top case 44 lt, cases 41-47 lt. All versions have black corners.



quick release

Sgancio rapido: il fissaggio avviene tramite sgancio rapido e necessita del telaietto originale BMW GS ADVENTURE.

Quick release: the fixing takes place through a quick release and requires the original compatible frame BMW GS ADVENTURE.

Utile per appendere il tuo casco.
Useful for hanging your helmet.



[Pag 78 Model-x GSA Laterali](#)
[Pag 78 Model-x GSA Side suitcase](#)

[Pag 146 Model-x GSA Bauletto](#)
[Pag 146 Model-x GSA Top case](#)

RAID



waterproof



lock system



aluminum



fixed release



quick release

Raid: la prima linea prodotta da Mytech, un irresistibile must-have con la massima affidabilità. La gamma Raid è in alluminio e rivestita con una finitura a polvere, garantendo resistenza.

Raid: The first line produced by Mytech, an irresistibile must-have that embodies maximum reliability. The Raid range is made from aluminum and coated with a powder finish, ensuring strength.



100% ALUMINUM

THE FIRST OF Mytech WORLD

LA PRIMA VERSIONE IN ALLUMINIO

*Fino ad esaurimento scorte

*Hurry while stocks last

RAID

Painted Aluminum



aluminum

Realizzata completamente in alluminio verniciato, nera o grigia. Le valigie sono verniciate a polvere per consentire maggior tenuta agli eventi atmosferici e agli urti.

It is entirely made from black or grey aluminum. The cases are anodized to allow greater resistance to atmospheric events and impacts.



fixed release

Disponibili in due versioni: nera con angolari grigi e grigia con angolari neri.

Available in two versions: black with grey corners and grey with black corners.

quick release

Sgancio: disponibile valigia con sgancio rapido e sgancio fisso a scelta.

Release: suitcase available with quick release and fixed release of your choice.

Utile per appendere il tuo casco.
Useful for hanging your helmet.

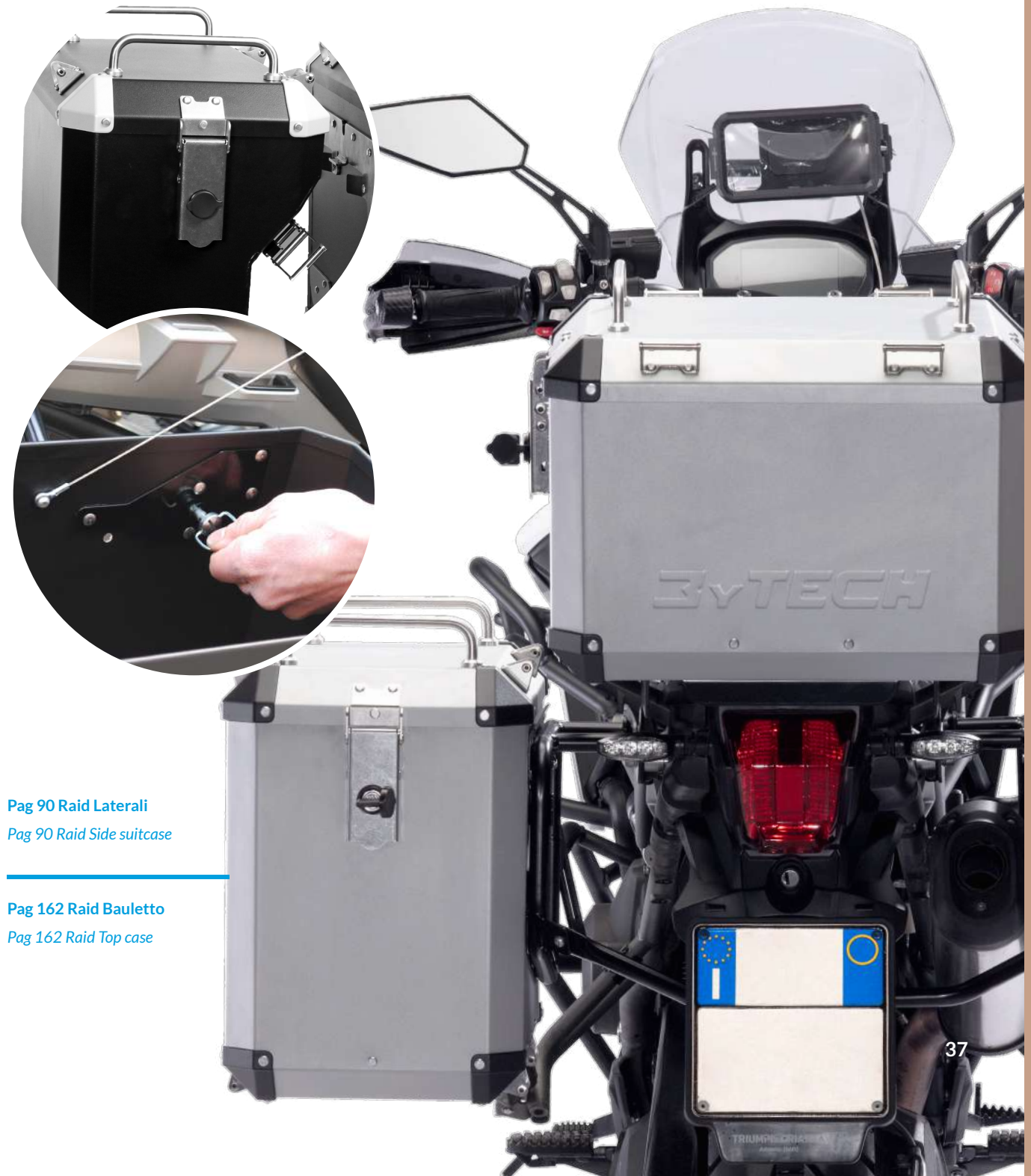
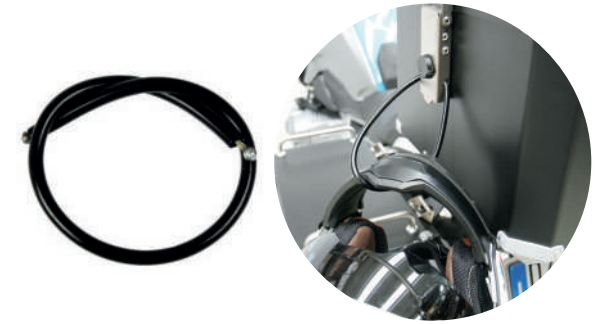

[Pag 90 Raid Laterali](#)
[Pag 90 Raid Side suitcase](#)

[Pag 162 Raid Bauletto](#)
[Pag 162 Raid Top case](#)

RAID GSA



waterproof



lock system



aluminum



attacks



quick release

Modello specifico per BMW GS Adventure, monta direttamente sui telai originali. Interamente in alluminio, compresi gli angolari e verniciata a polvere per garantire resistenza a graffi e corrosione.

Specific model for BMW GS Adventure, mounts directly on the original frames. Entirely in aluminum, including corners and powder coated to ensure resistance to scratches and corrosion.



FOR ORIGINAL FRAME

BMW GS ADVENTURE

PER TELAIO ORIGINALE BMW

*Fino ad esaurimento scorte

*Hurry while stocks last

RAID GSA

Painted Aluminum

Monta direttamente sul telaio originale BMW GS Adventure. Realizzata completamente in alluminio verniciato, nera o grigia. Le valigie sono verniciate a polvere per consentire maggior tenuta agli eventi atmosferici e agli urti.

Mounts directly to the original BMW GS Adventure chassis. Made entirely of painted aluminum, black or grey. The cases are anodized to allow greater resistance to atmospheric events and impacts.



Grey

Black

Utile per appendere il tuo casco.
Useful for hanging your helmet.



customize

Disponibili in due versioni: nera con angolari grigi e grigia con angolari neri.

Available in two versions: black with grey corners and grey with black corners.

quick release

Sgancio: disponibile valigia con sgancio rapido e sgancio fisso a scelta.

Release: suitcase available with quick release and fixed release of your choice.

[Pag 108 Raid GSA Laterali](#)
[Pag 108 Raid GSA Side suitcase](#)

SMART TANK



waterproof



lock system



aluminum



fixed release

Non sempre si ha l'esigenza di avere grandi spazi a bordo delle proprie moto. Oppure, pur avendoli, manca proprio un contenitore dedicato a piccole cose da tenere sempre a portata di mano. Per queste esigenze, Mytech ha creato Smart Tank, dedicato a modelli Triumph e Suzuki.

You don't always need to have large spaces on board your motorcycles. Or, despite having them, one is missing container dedicated to small things to always keep at hand. For these needs, Mytech has created Smart Tank, dedicated to Triumph and Suzuki models.



TRIUMPH AND SUZUKI

PER TELAIO SPECIFICO

FOR SPECIFIC FRAME

*Fino ad esaurimento scorte

*Hurry while stocks last

SMART TANK

Painted Aluminum

Smart Tank è composto da corpo nero in alluminio verniciato a polvere, coperchio disponibile in diverse colorazioni sempre in alluminio e cerniera in acciaio burattato.

Smart Tank is made up of a black body in powder-coated aluminum, lid available in different colors always in aluminum and hinge in tumbled steel.



Telaio specifico per Suzuki/Triumph
Specific frame for Suzuki/Triumph



Pag 112 Smart Tank
Pag 112 Smart Tank

customize

Smart Tank è disponibile in due versioni da 7,5 lt e 12 lt.

Smart Tank is available in two versions of 7.5 and 12 liters.

fixed release

Realizzate in solido alluminio da 1,5mm hanno la chiusura in acciaio a chiave e vengono fornite con staffe di fissaggio dedicate.

Made of solid 1.5mm aluminum, they have a steel key lock and are supplied with dedicated fixing brackets.

VALIGIE LATERALI

Side Panniers

52 / SUPERLEGGERA

56 / MODEL - X

74 / MODEL - X RAW

78 / MODEL - X GSA

82 / RAID PRO

88 / SOFT-X

90 / RAID

108 / RAID GSA

112 / SMART TANK



VALIGIE LATERALI Side Panniers

SUPERLEGGERA



Valigia in alluminio e carbonio
40Lt - 47Lt

pag. 52

MODEL-X



Valigia in alluminio
32Lt - 39Lt / 41Lt - 48Lt

pag. 56

MODEL-X



Valigia in alluminio
32Lt - 39Lt / 41Lt - 48Lt

pag. 58

MODEL-X RAW



Valigia in alluminio
32Lt - 39Lt / 41Lt - 48Lt

pag. 74

MODEL-X GSA



Valigia in alluminio
41Lt - 48Lt

pag. 78

MODEL-X GSA



Valigia in alluminio
41Lt - 48Lt

pag. 78

MODEL-X



Valigia in alluminio
32Lt - 39Lt / 41Lt - 48Lt

pag. 60

MODEL-X



Valigia in alluminio
32Lt - 39Lt / 41Lt - 48Lt

pag. 62

MODEL-X



Valigia in alluminio
32Lt - 39Lt / 41Lt - 48Lt

pag. 64

RAID PRO



Valigia in alluminio
32Lt - 39Lt / 41Lt - 48Lt

pag. 82

RAID PRO



Valigia in alluminio
32Lt - 39Lt / 41Lt - 48Lt

pag. 84

SOFT-X



Valigia morbida
34Lt - 34Lt

pag. 88

MODEL-X



Valigia in alluminio
32Lt - 39Lt / 41Lt - 48Lt

pag. 66

MODEL-X



Valigia in alluminio
32Lt - 39Lt / 41Lt - 48Lt

pag. 68

MODEL-X



Valigia in alluminio
32Lt - 39Lt / 41Lt - 48Lt

pag. 70

RAID



Valigia in alluminio
33Lt - 39Lt / 41Lt - 47Lt
**Hurry while stocks last*

pag. 90

RAID



Valigia in alluminio
33Lt - 39Lt / 41Lt - 47Lt
**Hurry while stocks last*

pag. 94

RAID



Valigia in alluminio
39Lt - 39Lt / 47Lt - 47Lt
**Hurry while stocks last*

pag. 98

VALIGIE LATERALI Side Panniers

RAID



Valigia in alluminio
39Lt - 39Lt / 47Lt - 47Lt
**Hurry while stocks last*
pag. 102



Valigia in alluminio
41Lt - 47Lt
**Hurry while stocks last*
pag. 108

RAID GSA



Valigia in alluminio
41Lt - 47Lt
**Hurry while stocks last*
pag. 108



Superleggera

Valigie laterali
Side suitcase

40 - 47lt



Superleggera
40-47 Lt



superlight



aluminum



carbon



waterproof



lock system



push block



quick release

Specifiche tecniche / Technical specifications

Superleggera

40lt Cod. VS0017NS
481.5x 245 x391.3mm
Weight: 3,8 Kg

47lt Cod. VD0017NS
481.5x 245 x391.3mm
Weight: 3,8 Kg

INFO

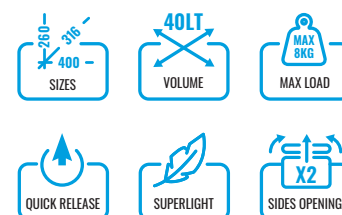

INFO



Aluminum and Carbon



OPTIONAL ACCESSORI



Superleggera Frames
*VARIABLE



Helmet cable
CAV099



Inner Bag 41lt
BI0011 - BI011A



Inner Bag 48lt
BI0012 - BI012A



Cavo casco
Helmet cable

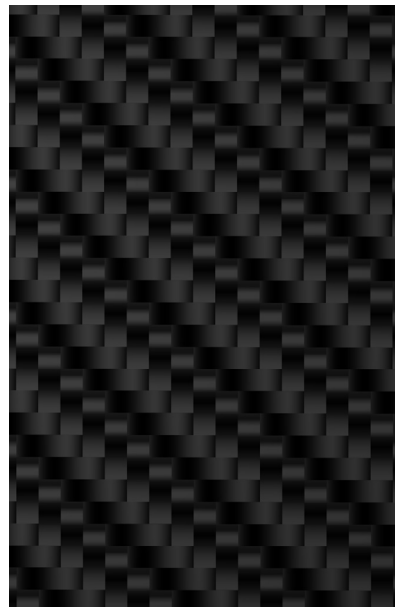

Fibra di carbonio - 44% Peso
Carbon fiber - 44% Weight



Dettagli
Details



SPARE PARTS Superleggera RICAMBI



Hinge black
ASSC10N



X2
Rotor lock 2pz
ROT002X



X6
Rotor lock 6pz
ROT006X



X9
Rotor lock 9pz
ROT009X



MODEL - X

Valigie laterali
Side suitcase



32 - 39lt

Model-x Small
32 - 39Lt



41 - 48lt

Model-x Large
41 - 48Lt



customize



aluminum



waterproof



lock system



push block



quick release

Specifiche tecniche / Technical specifications

SMALL

32lt Cod. VS0008NN
481.5x 245 x391.3mm
Weight: 6 Kg

39lt Cod. VD0008NN
481.5x 245 x391.3mm
Weight: 6,3 Kg

INFO

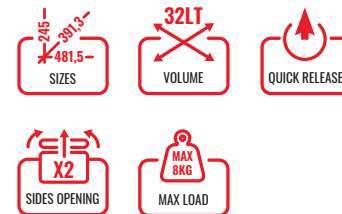

INFO

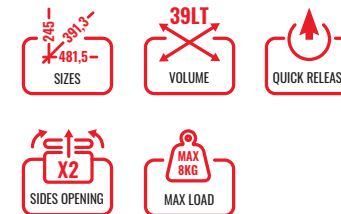

LARGE

41lt Cod. VS0007NN
481.5x 289 x391.3mm
Weight: 6,5 Kg

48lt Cod. VD0007NN
481.5x 289 x391.3mm
Weight: 6,8 Kg

INFO

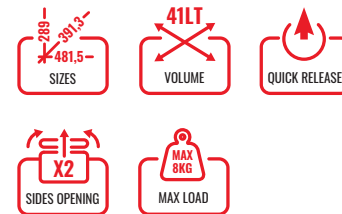

INFO

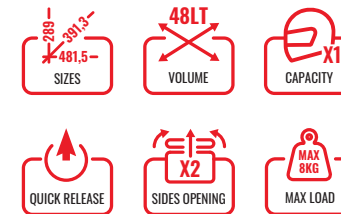

Black Aluminum body ●

Black corners ●

OPTIONAL



Model-x Frames
*VARIABLE



Helmet cable
CAV099



Outer Bag 15lt
BI0004



Handles 32/39lt 41/48lt
ASSC006 - ASSC007



Inner Bag 32lt
BI0009 - BI009A



Inner Bag 39lt
BI0010 - BI010A



Inner Bag 41lt
BI0011 - BI011A



Inner Bag 48lt
BI0012 - BI012A

MODEL - X

Valigie laterali
Side suitcase



32 - 39lt

Model-x Small
32 - 39Lt



41 - 48lt

Model-x Large
41 - 48Lt



customize



aluminum



waterproof



lock system



push block



quick release

Specifiche tecniche / Technical specifications

SMALL

32lt Cod. VS0008SN
481.5x 245 x391.3mm
Weight: 6 Kg

39lt Cod. VD0008SN
481.5x 245 x391.3mm
Weight: 6,3 Kg

INFO

- SIZES: 245-391.3 / 481.5
- VOLUME: 32LT
- QUICK RELEASE
- SIDES OPENING: X2
- MAX LOAD: MAX BKG

INFO

- SIZES: 245-391.3 / 481.5
- VOLUME: 39LT
- QUICK RELEASE
- SIDES OPENING: X2
- MAX LOAD: MAX BKG

LARGE

41lt Cod. VS0007SN
481.5x 289 x391.3mm
Weight: 6,5 Kg

48lt Cod. VD0007SN
481.5x 289 x391.3mm
Weight: 6,8 Kg

INFO

- SIZES: 289-391.3 / 481.5
- VOLUME: 41LT
- QUICK RELEASE
- SIDES OPENING: X2
- MAX LOAD: MAX BKG

INFO

- SIZES: 289-391.3 / 481.5
- VOLUME: 48LT
- CAPACITY: X1
- QUICK RELEASE
- SIDES OPENING: X2
- MAX LOAD: MAX BKG



Grey Aluminum body ●

Black corners ●

OPTIONAL



Model-x Frames
*VARIABLE



Helmet cable
CAV099



Outer Bag 15lt
BI0004



Handles 32/39lt 41/48lt
ASSC006 - ASSC007



Inner Bag 32lt
BI0009 - BI009A



Inner Bag 39lt
BI0010 - BI010A



Inner Bag 41lt
BI0011 - BI011A



Inner Bag 48lt
BI0012 - BI012A

MODEL - X

Valigie laterali
Side suitcase



32 - 39lt

Model-x Small
32 - 39Lt



41 - 48lt

Model-x Large
41 - 48Lt



customize



aluminum



waterproof



lock system



push block



quick release

Specifiche tecniche / Technical specifications

SMALL

32lt Cod. VS0008NA
481.5x 245 x391.3mm
Weight: 6 Kg

39lt Cod. VD0008NA
481.5x 245 x391.3mm
Weight: 6,3 Kg

INFO

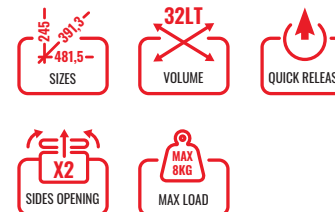

INFO

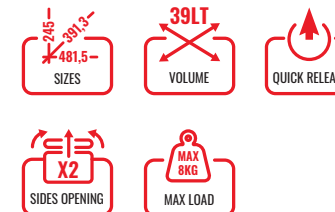

LARGE

41lt Cod. VS0007NA
481.5x 289 x391.3mm
Weight: 6,5 Kg

48lt Cod. VD0007NA
481.5x 289 x391.3mm
Weight: 6,8 Kg

INFO

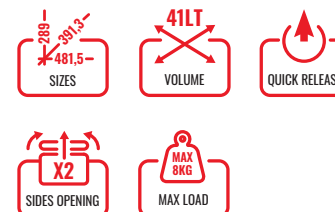

INFO

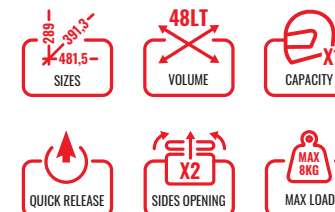

Black Aluminum body ●

Orange Corners ●

OPTIONAL



Model-x Frames
*VARIABLE



Helmet cable
CAV099



Outer Bag 15lt
BI0004



Handles 32/39lt 41/48lt
ASSC006 - ASSC007



Inner Bag 32lt
BI0009 - BI009A



Inner Bag 39lt
BI0010 - BI010A



Inner Bag 41lt
BI0011 - BI011A



Inner Bag 48lt
BI0012 - BI012A

MODEL - X

Valigie laterali
Side suitcase



32 - 39lt

Model-x Small
32 - 39Lt



41 - 48lt

Model-x Large
41 - 48Lt



customize



aluminum



waterproof



lock system



push block



quick release

Specifiche tecniche / Technical specifications

SMALL

32lt Cod. VS0008SA
481.5x 245 x391.3mm
Weight: 6 Kg

39lt Cod. VD0008SA
481.5x 245 x391.3mm
Weight: 6,3 Kg

INFO

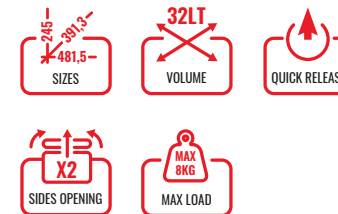

INFO

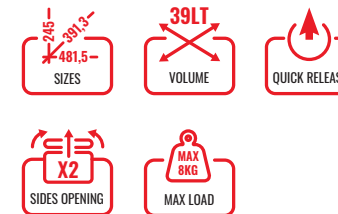

LARGE

41lt Cod. VS0007SA
481.5x 289 x391.3mm
Weight: 6,5 Kg

48lt Cod. VD0007SA
481.5x 289 x391.3mm
Weight: 6,8 Kg

INFO

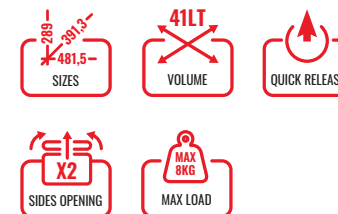

INFO

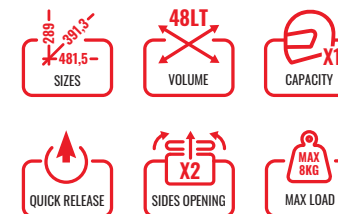

Grey Aluminum body ●

Orange Corners ●

OPTIONAL



Model-x Frames
*VARIABLE



Helmet cable
CAV099



Outer Bag 15lt
BI0004



Handles 32/39lt 41/48lt
ASSC006 - ASSC007



Inner Bag 32lt
BI0009 - BI009A



Inner Bag 39lt
BI0010 - BI010A



Inner Bag 41lt
BI0011 - BI011A



Inner Bag 48lt
BI0012 - BI012A

MODEL - X

Valigie laterali
Side suitcase



32 - 39lt

Model-x Small
32 - 39Lt



41 - 48lt

Model-x Large
41 - 48Lt



customize



aluminum



waterproof



lock system



push block



quick release

Specifiche tecniche / Technical specifications

SMALL

32lt Cod.VS0008NR
481.5x 245 x391.3mm
Weight: 6 Kg

39lt Cod.VD0008NR
481.5x 245 x391.3mm
Weight: 6,3 Kg

INFO

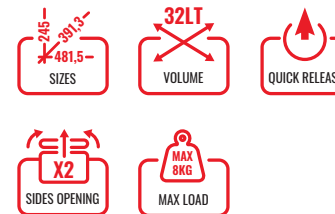

INFO

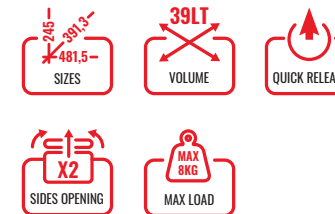

LARGE

41lt Cod. VS0007NR
481.5x 289 x391.3mm
Weight: 6,5 Kg

48lt Cod. VD0007NR
481.5x 289 x391.3mm
Weight: 6,8 Kg

INFO

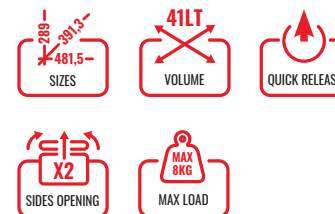

INFO

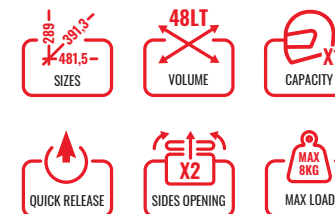

Black Aluminum body ●

Red Corners ●

OPTIONAL



Model-x Frames
*VARIABLE



Helmet cable
CAV099



Outer Bag 15lt
BI0004



Handles 32/39lt 41/48lt
ASSC006 - ASSC007



Inner Bag 32lt
BI0009 - BI009A



Inner Bag 39lt
BI0010 - BI010A



Inner Bag 41lt
BI0011 - BI011A



Inner Bag 48lt
BI0012 - BI012A

MODEL - X

Valigie laterali
Side suitcase



32 - 39lt

Model-x Small
32 - 39Lt



41 - 48lt

Model-x Large
41 - 48Lt



customize



aluminum



waterproof



lock system



push block



quick release

Specifiche tecniche / Technical specifications

SMALL

32lt Cod. VS0008SR
481.5x 245 x391.3mm
Weight: 6 Kg

39lt Cod. VD0008SR
481.5x 245 x391.3mm
Weight: 6,3 Kg

INFO

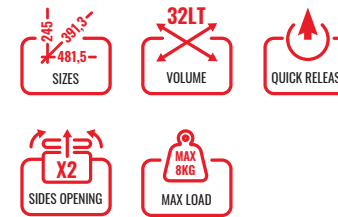

INFO

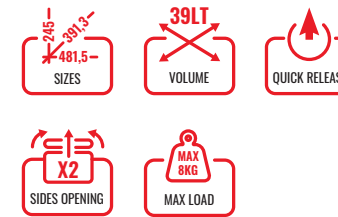

LARGE

41lt Cod. VS0007SR
481.5x 289 x391.3mm
Weight: 6,5 Kg

48lt Cod. VD0007SR
481.5x 289 x391.3mm
Weight: 6,8 Kg

INFO

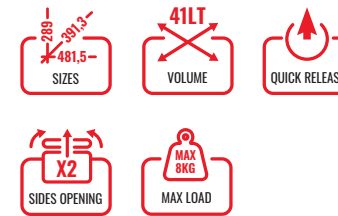

INFO

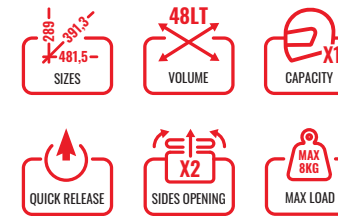

Grey Aluminum body ●

Red Corners ●

OPTIONAL



Model-x Frames
*VARIABLE



Helmet cable
CAV099



Outer Bag 15lt
BI0004



Handles 32/39lt 41/48lt
ASSC006 - ASSC007



Inner Bag 32lt
BI0009 - BI009A



Inner Bag 39lt
BI0010 - BI010A



Inner Bag 41lt
BI0011 - BI011A



Inner Bag 48lt
BI0012 - BI012A

MODEL - X

Valigie laterali
Side suitcase



32 - 39lt

Model-x Small
32 - 39Lt



41 - 48lt

Model-x Large
41 - 48Lt



customize



aluminum



waterproof



lock system



push block



quick release

Specifiche tecniche / Technical specifications

SMALL

32lt Cod.VS0008NB
481.5x 245 x391.3mm
Weight: 6 Kg

39lt Cod.VD0008NB
481.5x 245 x391.3mm
Weight: 6,3 Kg

INFO

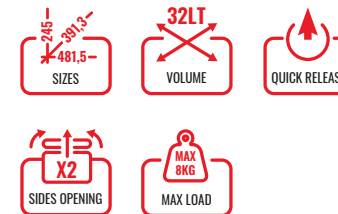

INFO

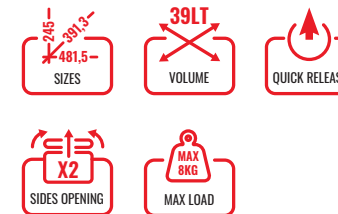

LARGE

41lt Cod. VS0007NB
481.5x 289 x391.3mm
Weight: 6,5 Kg

48lt Cod. VD0007NB
481.5x 289 x391.3mm
Weight: 6,8 Kg

INFO

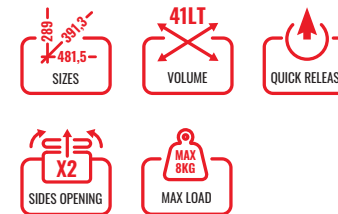

INFO

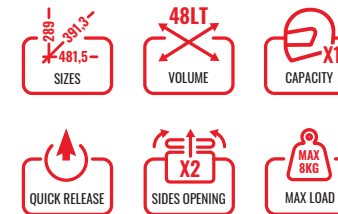

Black Aluminum body ●

Blue Corners ●

OPTIONAL



Model-x Frames
*VARIABLE



Helmet cable
CAV099



Outer Bag 15lt
BI0004



Handles 32/39lt 41/48lt
ASSC006 - ASSC007



Inner Bag 32lt
BI0009 - BI009A



Inner Bag 39lt
BI0010 - BI010A



Inner Bag 41lt
BI0011 - BI011A



Inner Bag 48lt
BI0012 - BI012A

MODEL - X

Valigie laterali
Side suitcase



32 - 39lt

Model-x Small
32 - 39Lt



41 - 48lt

Model-x Large
41 - 48Lt



customize



aluminum



waterproof



lock system



push block



quick release

Specifiche tecniche / Technical specifications

SMALL

32lt Cod. VS0008SB
481.5x 245 x391.3mm
Weight: 6 Kg

39lt Cod. VD0008SB
481.5x 245 x391.3mm
Weight: 6,3 Kg

INFO

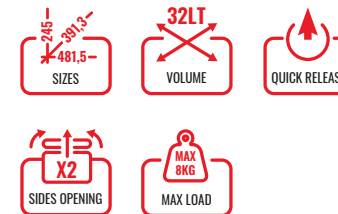

INFO

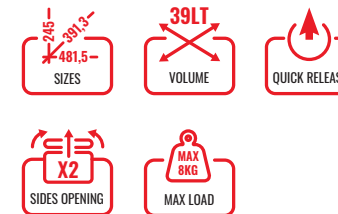

LARGE

41lt Cod. VS0007SB
481.5x 289 x391.3mm
Weight: 6,5 Kg

48lt Cod. VD0007SB
481.5x 289 x391.3mm
Weight: 6,8 Kg

INFO

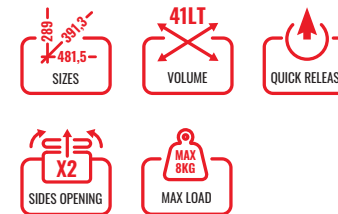

INFO

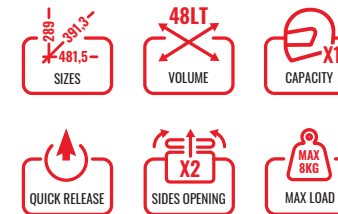

Grey Aluminum body ●

Blue Corners ●

OPTIONAL ACCESSORI



Model-x Frames
*VARIABLE



Helmet cable
CAV099



Outer Bag 15lt
BI0004



Handles 32/39lt 41/48lt
ASSC006 - ASSC007



Inner Bag 32lt
BI0009 - BI009A



Inner Bag 39lt
BI0010 - BI010A



Inner Bag 41lt
BI0011 - BI011A



Inner Bag 48lt
BI0012 - BI012A



Cavo casco
Helmet cable



Personalizzabili
Customized



Angolari
Corners



SPARE PARTS MODEL - X RICAMBI



Corners 4pz red
ASSC0R



Corners 4pz orange
ASSC0A



Corners 4pz blue
ASSCOB



Corners 4pz black
ASSCON



Hinge red
ASSC10R



Hinge orange
ASSC10A



Hinge blue
ASSC10B



Hinge black
ASSC10N



Handles 33/39lt
ASSC006



Handles 41/47lt
ASSC007



Strap hook
ASSC005



Rotor lock 2pz
ROT002X



Rotor lock 6pz
ROT006X



Rotor lock 9pz
ROT009X

MODEL - X RAW

Valigie laterali
Side suitcase



32 - 39lt

Model-x Raw Small
32 - 39Lt



41 - 48lt

Model-x Raw Large
41 - 48Lt



raw alu



waterproof



lock system



push block



quick release

Specifiche tecniche / Technical specifications

SMALL

32lt Cod. VS0013GN
481.5x 245 x391.3mm
Weight: 6 Kg

39lt Cod. VD0013GN
481.5x 245 x391.3mm
Weight: 6,3 Kg

INFO

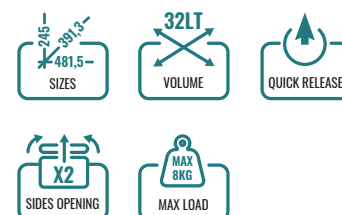

INFO

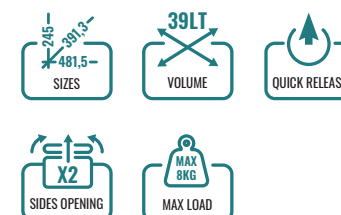

LARGE

41lt Cod. VS0012GN
481.5x 289 x391.3mm
Weight: 6,5 Kg

48lt Cod. VD0012GN
481.5x 289 x391.3mm
Weight: 6,8 Kg

INFO

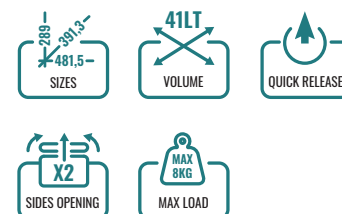

INFO

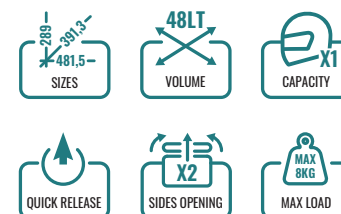

Raw Aluminum body

OPTIONAL ACCESSORI



Model-x Frames
*VARIABLE



Helmet cable
CAV099



Handles 32/39lt 41/48lt
ASSC006 - ASSC007



Inner Bag 32lt
BI0009 - BI009A



Inner Bag 39lt
BI0010 - BI010A



Inner Bag 41lt
BI0011 - BI011A



Inner Bag 48lt
BI0012 - BI012A



Cavo casco
Helmet cable



Alluminio grezzo
Raw aluminum



Senza angolari
No corners

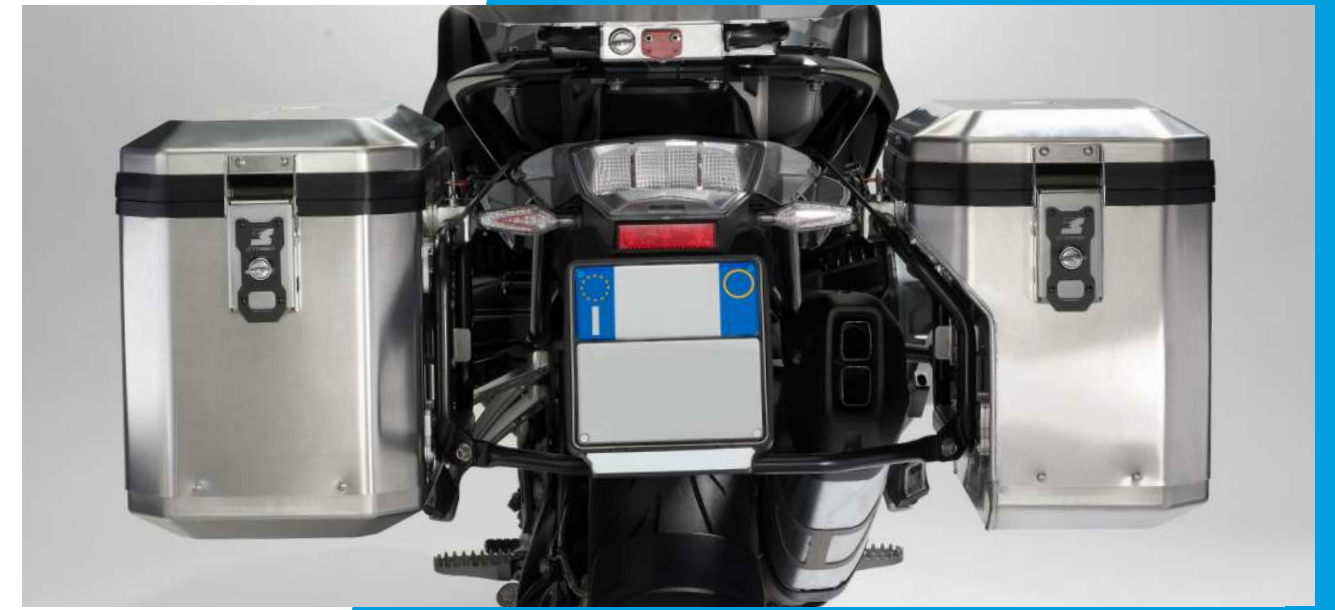

SPARE PARTS MODEL - XRAW RICAMBI



Hinge red
ASSC10R



Hinge orange
ASSC10A



Hinge blue
ASSC10B



Hinge black
ASSC10N



Handles 33/39lt
ASSC006



Handles 41/47lt
ASSC007



Strap hook
ASSC005



Rotor lock 2pz
ROT002X



Rotor lock 6pz
ROT006X



Rotor lock 9pz
ROT009X



La linea di valigie Model-x Raw può essere customizzata come vuoi tu con un wrapping high tech.
The Model-x Raw line of suitcases can be customized however you want with a high tech wrapping.

MODEL - X GSA

Valigie laterali
Side suitcase



41 - 48lt

Model-x GSA Raw
41 - 48 Lt



41 - 48lt

Model-x GSA Black
41 - 48 Lt



attacks



raw alu



waterproof



lock system



quick release

Specifiche tecniche / Technical specifications

RAW

41lt Cod. VSGS07GN
481.5x 289 x391.3mm
Weight: 6,5 Kg

48lt Cod. VDGS07GN
481.5x 289 x391.3mm
Weight: 6,8 Kg



INFO

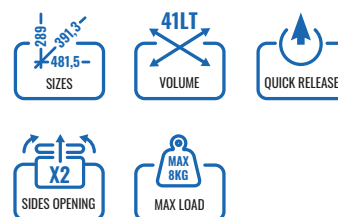

INFO

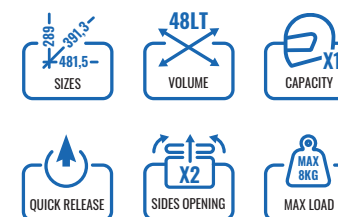

BLACK

41lt Cod. VSGS07NN
481.5x 289 x391.3mm
Weight: 6,5 Kg

48lt Cod. VDGS07NN
481.5x 289 x391.3mm
Weight: 6,8 Kg



INFO

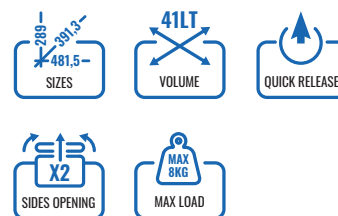

INFO

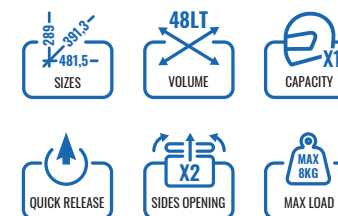

Raw or Black Aluminum body

Black Corners

OPTIONAL ACCESSORI



BMW Original Frames
*VARIABLE



Helmet cable
CAV099



Outer Bag 15lt
BI0004



Handles 41/48lt
ASSC006 - ASSC007



Inner Bag 41lt
BI0011 - BI011A



Inner Bag 48lt
BI0012 - BI012A



Cavo casco
Helmet cable



Solo per telai originali BMW
Only for original BMW frames



Nere o grezze
Black or raw



SPARE PARTS MODEL - X GSA RICAMBI



Corners 4pz red
ASSCOR



Corners 4pz orange
ASSCOA



Corners 4pz blue
ASSCOB



Corners 4pz black
ASSCON



Hinge red
ASSC10R



Hinge orange
ASSC10A



Hinge blue
ASSC10B



Hinge black
ASSC10N



Handles 41/47lt
ASSC007



Strap hook
ASSC005



Rotor lock 2pz
ROT002X



Rotor lock 6pz
ROT006X



Rotor lock 9pz
ROT009X



RAID PRO

Valigie laterali
Side suitcase



Raid Pro Large
48 - 41 Lt

48 - 41lt



Raid Pro Large
41 - 48 Lt

41 - 48lt



aluminum



waterproof



lock system



sliding



push block



quick release

Specifiche tecniche / Technical specifications

LARGE

41lt Cod. *
286 x 512 x h400mm
Weight: 4,6 Kg

48lt Cod. *
286 x 512 x h400mm
Weight: 4,8 Kg

INFO

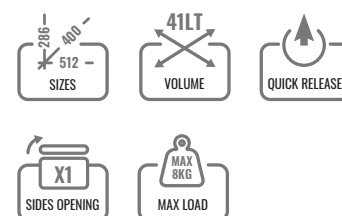

INFO

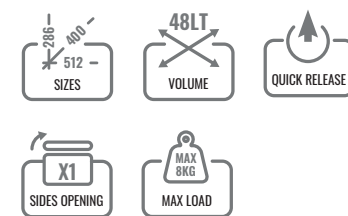

48lt Cod. VDSX9GN
Valigia dritta a sinistra
Suitcase straight to the left



41lt Cod. VSDX9GN
Valigia scaricata a destra
Suitcase unloaded on the right

48lt Cod. VDDX9GN
Valigia dritta a destra
Suitcase straight to the right

41lt Cod. VSSX9GN
Valigia scaricata a sinistra
Suitcase unloaded on the left

Raw Aluminum body

Black Corners

OPTIONAL



Model-x Frames
*VARIABLE



Helmet cable
CAV099



Outer Bag 15lt
BI0004



Inner Bag 48lt
BI0012 - BI012A



Inner Bag 32lt
BI0009 - BI009A



Inner Bag 39lt
BI0010 - BI010A



Inner Bag 41lt
BI0011 - BI011A

RAID PRO

Valigie laterali
Side suitcase

41 - 48lt



Raid Pro Large
41 - 48 Lt



Raid Pro Large
48 - 41 Lt

48 - 41lt



aluminum



waterproof



lock system



push block



quick release

Specifiche tecniche / Technical specifications

LARGE

41lt Cod.*
286 x 512 x h400mm
Weight: 4,6 Kg

48lt Cod.*
286 x 512 x h400mm
Weight: 4,8 Kg

INFO

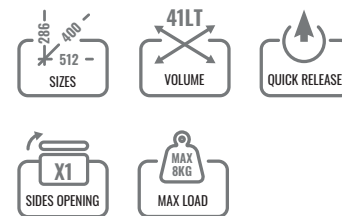

INFO

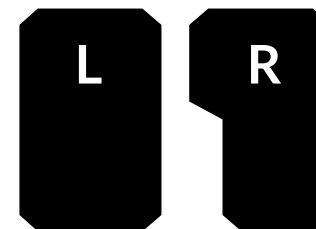
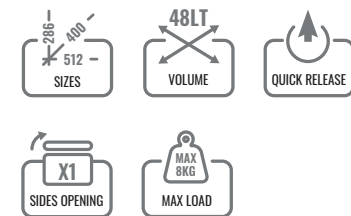

48lt Cod. VDSX9NN
Valigia dritta a sinistra
Suitcase straight to the left

41lt Cod. VSDX9NN
Valigia scaricata a destra
Suitcase unloaded on the right

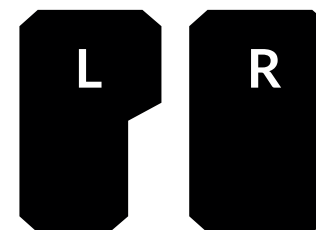

48lt Cod. VDDX9NN
Valigia dritta a destra
Suitcase straight to the right

41lt Cod. VSSX9NN
Valigia scaricata a sinistra
Suitcase unloaded on the left

Black Aluminum body ●
Black corners ●

OPTIONAL



Model-x Frames
*VARIABLE



Helmet cable
CAV099



Outer Bag 15lt
BI0004



Inner Bag 48lt
BI0012 - BI012A



Inner Bag 32lt
BI0009 - BI009A



Inner Bag 39lt
BI0010 - BI010A



Inner Bag 41lt
BI0011 - BI011A



Cavo casco
Helmet cable



Attacchi integrati
Integrated attacks



Lock System or Push Block
Lock System or Push Block



SPARE PARTS RAID PRO RICAMBI



Hinge red
ASSC10R



Hinge orange
ASSC10A



Hinge blue
ASSC10B



Hinge black
ASSC10N



X2
Rotor lock 2pz
ROT002X



X6
Rotor lock 6pz
ROT006X



X9
Rotor lock 9pz
ROT009X



SOFT-X VALIGIE LATERALI

SOFT-X Side Bags

34lt



SOFT-X Side bags
34 Lt



Fotorifrangente
Photoreflective



aluminum



pes



tpu



waterproof



lock system



push block



quick release

Specifiche tecniche / Technical specifications

SOFT-X SIDE BAG

34lt Cod. SX0034SN
420 x 180 x 330mm
Side bag weight: 0,7 Kg

INFO

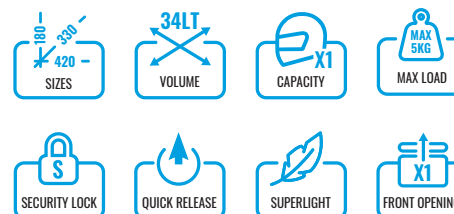
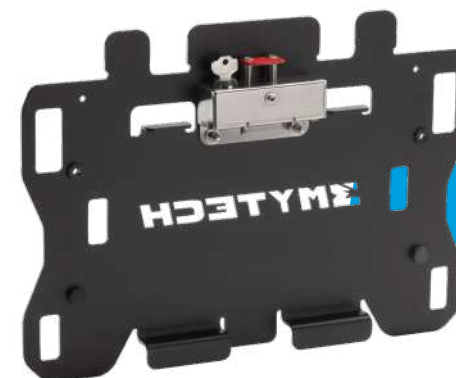

PLATE FOR PUSH BLOCK FRAMES



Plate

Piastra lato dritto
Plate straight side

Cod. PPT021PB

Plate

Piastra lato scarico
Plate discharged side

Cod. PPT022PB



Vano porta oggetti lato scaricato
Glove compartment discharged side

Pag 190 Soft-x Top Bag
Pag 190 Soft-x Top Bag



Polyester and TPU

RAID

Valigie laterali
Side suitcase

33 - 39lt



Raid small
33 - 39Lt

41 - 47lt



Raid large
41 - 47 Lt



aluminum



waterproof



lock system



fixed release



quick release

Specifiche tecniche / Technical specifications

SMALL Cod. *next page

33lt
468 x 235 x 380mm
Weight: 6,2 Kg

39lt
468 x 235 x 380mm
Weight: 6,5 Kg



INFO

- SIZES: 235-380 / 468
- VOLUME: 33LT
- QUICK RELEASE
- FIXED RELEASE
- SIDES OPENING: X2
- MAX LOAD

INFO

- SIZES: 235-380 / 468
- VOLUME: 39LT
- QUICK RELEASE
- FIXED RELEASE
- SIDES OPENING: X2
- MAX LOAD

LARGE Cod. *next page

41lt
468 x 270 x 400mm
Weight: 6,7 Kg

47lt
468 x 270 x 400mm
Weight: 7 Kg



INFO

- SIZES: 270-400 / 468
- VOLUME: 41LT
- QUICK RELEASE
- FIXED RELEASE
- SIDES OPENING: X2
- MAX LOAD

INFO

- SIZES: 270-400 / 468
- VOLUME: 47LT
- CAPACITY: X1
- QUICK RELEASE
- FIXED RELEASE
- SIDES OPENING: X2

MAX LOAD

Black Aluminum body ●
Alluminum Corners ●

OPTIONAL



Raid Frames
*VARIABLE



Helmet cable
CAV099



Outer Bag 15lt
BI0004



Handles 33/39lt 41/47lt
ASSC003 - ASSC004



Inner Bag
BI0001



Tank and Tank Holder
BMW413 - TNK200

Raid SGANCIO FISSO

Specifiche tecniche / Technical specifications

INFO



Black Aluminum body ●

Alluminum Corners ●



L **39lt** Cod. VD0006FNS
Valigia dritta a sinistra
Suitcase straight to the left



R **33lt** Cod. VS0005FNS
Valigia scaricata a destra
Suitcase unloaded on the right



R **39lt** Cod. VD0005FNS
Valigia dritta a destra
Suitcase straight to the right



L **33lt** Cod. VS0006FNS
Valigia scaricata a sinistra
Suitcase unloaded on the left



L **47lt** Cod. VD0002FNS
Valigia dritta a sinistra
Suitcase straight to the left



R **41lt** Cod. VS0001FNS
Valigia scaricata a destra
Suitcase unloaded on the right



R **47lt** Cod. VD0001FNS
Valigia dritta a destra
Suitcase straight to the right



L **41lt** Cod. VS0002FNS
Valigia scaricata a sinistra
Suitcase unloaded on the left



Raid SGANCIO RAPIDO

Specifiche tecniche / Technical specifications

INFO



Black Aluminum body ●

Alluminum Corners ●



L **39lt** Cod. VD0006RNS
Valigia dritta a sinistra
Suitcase straight to the left



R **33lt** Cod. VS0005RNS
Valigia scaricata a destra
Suitcase unloaded on the right



R **39lt** Cod. VD0005RNS
Valigia dritta a destra
Suitcase straight to the right



L **33lt** Cod. VS0006RNS
Valigia scaricata a sinistra
Suitcase unloaded on the left



L **47lt** Cod. VD0002RNS
Valigia dritta a sinistra
Suitcase straight to the left



R **41lt** Cod. VS0001RNS
Valigia scaricata a destra
Suitcase unloaded on the right



R **47lt** Cod. VD0001RNS
Valigia dritta a destra
Suitcase straight to the right



L **41lt** Cod. VS0002RNS
Valigia scaricata a sinistra
Suitcase unloaded on the left



RAID

Valigie laterali
Side suitcase



33 - 39lt

Raid small
33 - 39Lt



41 - 47lt

Raid large
41 - 47 Lt



aluminum



waterproof



lock system



fixed release



quick release

Specifiche tecniche / Technical specifications

SMALL Cod. * next page

33lt
468 x 235 x 380mm
Weight: 6,2 Kg

39lt
468 x 235 x 380mm
Weight: 6,5 Kg



INFO

- SIZES: 235-380 / 468
- VOLUME: 33LT
- QUICK RELEASE
- FIXED RELEASE
- SIDES OPENING: X2
- MAX LOAD: MAX 8KG

INFO

- SIZES: 235-380 / 468
- VOLUME: 39LT
- QUICK RELEASE
- FIXED RELEASE
- SIDES OPENING: X2
- MAX LOAD: MAX 8KG

LARGE Cod. * next page

41lt
468 x 270 x 400mm
Weight: 6,7 Kg

47lt
468 x 270 x 400mm
Weight: 7 Kg



INFO

- SIZES: 270-400 / 468
- VOLUME: 41LT
- QUICK RELEASE
- FIXED RELEASE
- SIDES OPENING: X2
- MAX LOAD: MAX 8KG

INFO

- SIZES: 270-400 / 468
- VOLUME: 47LT
- CAPACITY: X1
- QUICK RELEASE
- FIXED RELEASE
- SIDES OPENING: X2

MAX LOAD

Grey Aluminum body ●
Alluminum Corners ●

OPTIONAL



Raid Frames
*VARIABLE



Helmet cable
CAV099



Outer Bag 15lt
BI0004



Handles 33/39lt 41/47lt
ASSC003 - ASSC004



Inner Bag
BI0001



Tank and Tank Holder
BMW413 - TNK200

Raid SGANCIO FISSO

Specifiche tecniche / Technical specifications

INFO



Grey Aluminum body ●

Alluminum Corners ●



L **39lt** Cod. VD0006FSN
Valigia dritta a sinistra
Suitcase straight to the left



R **33lt** Cod. VS0005FSN
Valigia scaricata a destra
Suitcase unloaded on the right



R **39lt** Cod. VD0005FSN
Valigia dritta a destra
Suitcase straight to the right



L **33lt** Cod. VS0006FSN
Valigia scaricata a sinistra
Suitcase unloaded on the left



L **47lt** Cod. VD0002FSN
Valigia dritta a sinistra
Suitcase straight to the left



R **41lt** Cod. VS0001FSN
Valigia scaricata a destra
Suitcase unloaded on the right



R **47lt** Cod. VD0001FSN
Valigia dritta a destra
Suitcase straight to the right



L **41lt** Cod. VS0002FSN
Valigia scaricata a sinistra
Suitcase unloaded on the left



Raid SGANCIO RAPIDO

Specifiche tecniche / Technical specifications

INFO



Grey Aluminum body ●

Alluminum Corners ●



L **39lt** Cod. VD0006RSN
Valigia dritta a sinistra
Suitcase straight to the left



R **33lt** Cod. VS0005RSN
Valigia scaricata a destra
Suitcase unloaded on the right



R **39lt** Cod. VD0005RSN
Valigia dritta a destra
Suitcase straight to the right



L **33lt** Cod. VS0006RSN
Valigia scaricata a sinistra
Suitcase unloaded on the left



L **47lt** Cod. VD0002RSN
Valigia dritta a sinistra
Suitcase straight to the left



R **41lt** Cod. VS0001RSN
Valigia scaricata a destra
Suitcase unloaded on the right



R **47lt** Cod. VD0001RSN
Valigia dritta a destra
Suitcase straight to the right



L **41lt** Cod. VS0002RSN
Valigia scaricata a sinistra
Suitcase unloaded on the left



RAID

Valigie laterali
Side suitcase



39 - 39lt

Raid small
39 - 39Lt



47 - 47lt

Raid large
47 - 47 Lt



aluminum



waterproof



lock system



fixed release



quick release

Specifiche tecniche / Technical specifications

SMALL Cod. * next page

39lt
468 x 235 x 380mm
Weight: 6,5Kg

39lt
468 x 235 x 380mm
Weight: 6,5 Kg



INFO



INFO



LARGE Cod. * next page

47lt
468 x 270 x 400mm
Weight: 7 Kg

47lt
468 x 270 x 400mm
Weight: 7Kg



INFO



INFO



Black Aluminum body ●

Alluminum Corners ●

OPTIONAL



Raid Frames
*VARIABLE



Helmet cable
CAV099



Outer Bag 15lt
BI0004



Handles 33/39lt 41/47lt
ASSC003 - ASSC004



Inner Bag
BI0001



Tank and Tank Holder
BMW413 - TNK200

Raid SGANCIO FISSO

Specifiche tecniche / Technical specifications

INFO



Black Aluminum body ●

Alluminum Corners ●



L **39lt** Cod. VD0006FNS
Valigia dritta a sinistra
Suitcase straight to the left



R **39lt** Cod. VD0005FNS
Valigia dritta a destra
Suitcase straight to the right



L **47lt** Cod. VD0002FNS
Valigia dritta a sinistra
Suitcase straight to the left



R **47lt** Cod. VD0001FNS
Valigia dritta a destra
Suitcase straight to the right



Raid SGANCIO RAPIDO

Specifiche tecniche / Technical specifications

INFO



Black Aluminum body ●

Alluminum Corners ●



L **39lt** Cod. VD0006RNS
Valigia dritta a sinistra
Suitcase straight to the left



R **39lt** Cod. VD0005RNS
Valigia dritta a destra
Suitcase straight to the right



L **47lt** Cod. VD0002RNS
Valigia dritta a sinistra
Suitcase straight to the left



R **47lt** Cod. VD0001RNS
Valigia dritta a destra
Suitcase straight to the right



RAID

Valigie laterali
Side suitcase



Raid small
39 - 39Lt

39 - 39lt



Raid large
47 - 47 Lt

47 - 47lt



aluminum



waterproof



lock system



fixed release



quick release

Specifiche tecniche / Technical specifications

SMALL Cod. * next page

39lt
468 x 235 x 380mm
Weight: 6,5 Kg

39lt
468 x 235 x 380mm
Weight: 6,5 Kg



INFO

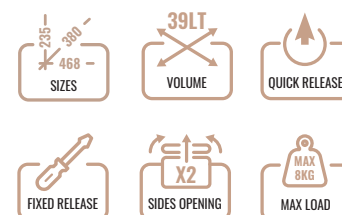

INFO



LARGE Cod. * next page

47lt
468 x 270 x 400mm
Weight: 7 Kg

47lt
468 x 270 x 400mm
Weight: 7 Kg



INFO



INFO



Grey Aluminum body ●

Alluminum Corners ●

OPTIONAL ACCESSORI



Raid Frames
*VARIABLE



Helmet cable
CAV099



Outer Bag 15lt
BI0004



Handles 33/39lt 41/47lt
ASSC003 - ASSC004



Inner Bag
BI0001



Tank and Tank Holder
BMW413 - TNK200

Raid SGANCIO FISSO

Specifiche tecniche / Technical specifications

INFO



Grey Aluminum body ●

Alluminum Corners ●



L **39lt** Cod. VD0006FSN
Valigia dritta a sinistra
Suitcase straight to the left



R **39lt** Cod. VD0005FSN
Valigia dritta a destra
Suitcase straight to the right



L **47lt** Cod. VD0002FSN
Valigia dritta a sinistra
Suitcase straight to the left



R **47lt** Cod. VD0001FSN
Valigia dritta a destra
Suitcase straight to the right



Raid SGANCIO RAPIDO

Specifiche tecniche / Technical specifications

INFO



Grey Aluminum body ●

Alluminum Corners ●



L **39lt** Cod. VD0006RSN
Valigia dritta a sinistra
Suitcase straight to the left



R **39lt** Cod. VD0005RSN
Valigia dritta a destra
Suitcase straight to the right



L **47lt** Cod. VD0002RSN
Valigia dritta a sinistra
Suitcase straight to the left



R **47lt** Cod. VD0001RSN
Valigia dritta a destra
Suitcase straight to the right





Cavo casco
Helmet cable



Maniglie
Handles



Tanica e porta tanica
Tank



SPARE PARTS Raid RICAMBI



Hinge
ASSC001



Strap hook
ASSC002



Handles 33/39lt
ASSC003



Handles 41/47lt
ASSC004



Rotor lock 1pz
ROT495R



Rotor lock 2pz
ROT195R



Rotor lock 4pz
ROT295R



Rotor lock 6pz
ROT695R



Rotor lock 7pz
ROT795R



RAID GSA

Valigie laterali
Side suitcase



41 - 47lt

Raid GSA
41 - 47Lt



41 - 47lt

Raid GSA
41 - 47Lt



attacks



aluminum



waterproof



lock system



quick release

Specifiche tecniche / Technical specifications

BLACK

41lt Cod. VS0GS1RNS
468 x 270 x 400mm
Weight: 6,7 Kg

47lt Cod. VD0GS1RNS
468 x 270 x 400mm
Weight: 7 Kg



INFO



INFO

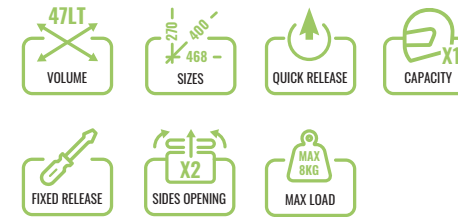

SILVER Cod. * next page

41lt Cod. VS0GS1RSN
468 x 270 x 400mm
Weight: 6,7 Kg

47lt Cod. VD0GS1RSN
468 x 270 x 400mm
Weight: 7 Kg



INFO



INFO

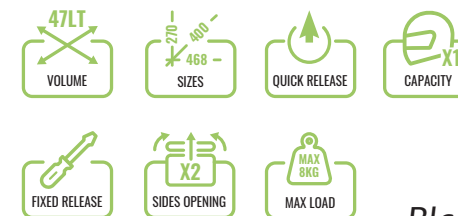

Black or grey Aluminum body

Aluminum Corners

OPTIONAL ACCESSORI



BMW Original Frames
*VARIABLE



Helmet cable
CAV099



Outer Bag 15lt
BI0004



Handles 41/47lt
ASSC004



Inner Bag
BI0001



Tank and Tank Holder
BMW413 - TNK200



Cavo casco
Helmet cable



Maniglie
Handles



Tanica e porta tanica
Tank



SPARE PARTSraid RICAMBI

 Hinge ASSC001	 Strap hook ASSC002	 Handles 41/47lt ASSC004	 Rotor lock 1pz ROT495R
 Rotor lock 2pz ROT195R	 Rotor lock 4pz ROT295R	 Rotor lock 6pz ROT695R	 Rotor lock 7pz ROT795R

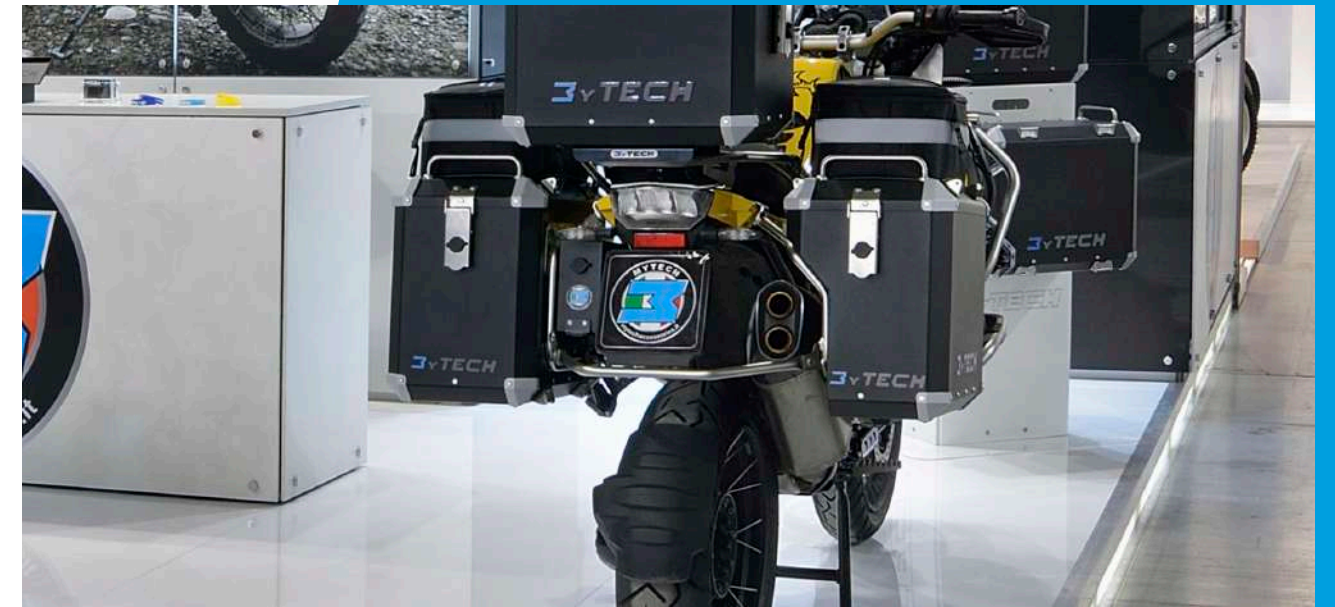

SMART TANK

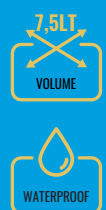

7,5lt

Valigia Smart Tank

Cod * Variable



Black ●

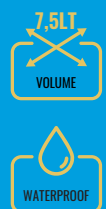

7,5lt

Valigia Smart Tank

Cod * Variable



Blue ●



aluminum



waterproof



lock system



fixed release



7,5lt

Valigia Smart Tank

Cod * Variable



Gold ●



7,5lt

Valigia Smart Tank

Cod * Variable



Red ●



7,5lt

Valigia Smart Tank

Cod * Variable



White ○



12lt

Valigia Smart Tank

Cod * Variable



Black ●



12lt

Valigia Smart Tank

Cod * Variable



Red ●



12lt

Valigia Smart Tank

Cod * Variable

Blue ●



12lt

Valigia Smart Tank

Cod * Variable

White ○



12lt

Valigia Smart Tank

Cod * Variable



Gold ●

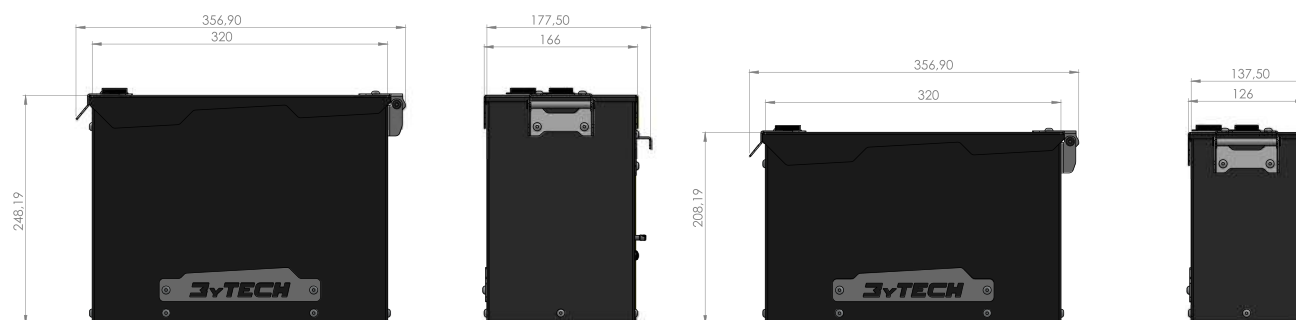

12lt

7,5lt

Top case

Top cases

120 / SUPERLEGGERA

124 / MODEL - X

142 / MODEL - X RAW

146 / MODEL - X GSA

152 / RAID PRO

156 / LIGHT

162 / RAID



Top case | Top cases

SUPERLEGGERA



Valigia in alluminio e carbonio
42Lt

pag. 120

MODEL - X



Valigia in alluminio
44Lt / 58Lt

pag. 124

MODEL - X



Valigia in alluminio
44Lt / 58Lt

pag. 126

MODEL - X RAW



Valigia in alluminio
44Lt / 58Lt

pag. 142

MODEL - X GSA



Valigia in alluminio
44Lt / 58Lt

pag. 146

MODEL - X GSA



Valigia in alluminio
44Lt / 58Lt

pag. 148

MODEL - X



Valigia in alluminio
44Lt / 58Lt

pag. 128

MODEL - X



Valigia in alluminio
44Lt / 58Lt

pag. 130

MODEL - X



Valigia in alluminio
44Lt / 58Lt

pag. 132

RAID PRO



Valigia in alluminio
44Lt / 58Lt

pag. 152

RAID PRO



Valigia in alluminio
44Lt / 58Lt

pag. 152

LIGHT



Valigia in alluminio
60Lt

pag. 156

MODEL - X



Valigia in alluminio
44Lt / 58Lt

pag. 134

MODEL - X



Valigia in alluminio
44Lt / 58Lt

pag. 136

MODEL - X



Valigia in alluminio
44Lt / 58Lt

pag. 138

RAID



Valigia in alluminio
33Lt

*Hurry while stocks last
pag. 162

RAID



Valigia in alluminio
41Lt

*Hurry while stocks last
pag. 164

RAID



Valigia in alluminio
55Lt

*Hurry while stocks last
pag. 166

Superleggera

Top case
Top cases



Bauletto
Top case

42lt



aluminum



pes



tpu



waterproof



lock system



push block



quick release

Specifiche tecniche / Technical specifications

SMALL

42lt Cod. TC0016NS
400 x 360 x 316mm
Top case weight: 3,7 Kg

INFO



● Aluminum and Carbon

OPTIONAL



Quick release Plate
*VARIABLE



Helmet cable
CAV099



Backrest
TC00S4



Inner Bag black 42lt
BI0007



Inner Bag orange 42lt
BI0007A



Inner Bag expandible 33-55lt
BI0002



Mat
TA0044



Cavo casco
Helmet cable



Schienalino
Backrest



Tappetino per 42lt
Mat for 42lt



SPARE PARTS Superleggera RICAMBI



Hinge black
ASSC10N



X2
Rotor lock 2pz
ROT002X



X6
Rotor lock 6pz
ROT006X



X9
Rotor lock 9pz
ROT009X



MODEL - X

Top case
Top cases



44lt

Model-x Small
44 Lt



58lt

Model-x Large
58 Lt



customize



aluminum



waterproof



lock system



push block



quick release

Specifiche tecniche / Technical specifications

SMALL

44lt Cod. TC0010NN
405 x 395 x 310mm
Top case weight: 6,2 Kg



INFO

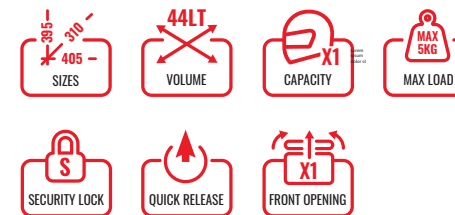

LARGE

58lt Cod. TC0011NN
535 x 395 x 310mm
Top case weight: 7,2 Kg



INFO

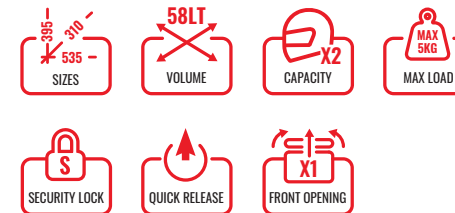

Black Aluminum body ●

Black corners ●

OPTIONAL



Quick release Plate
*VARIABLE



Helmet cable
CAV099



Backrest
TC00S4



Mat
TA0044



Handles 44lt - 58lt
ASSC008 - ASSC009



Inner Bag expandible 33-55lt
BI0002



Inner Bag 44lt
BI0007 - BI007A



Inner Bag 58lt
BI0008 - BI008A

MODEL - X

Top case
Top cases

44lt



Model-x Small
44 Lt

58lt



Model-x Large
58 Lt



customize



aluminum



waterproof



lock system



push block



quick release

Specifiche tecniche / Technical specifications

SMALL

44lt Cod. TC0010SN
405 x 395 x 310mm
Top case weight: 6,2 Kg



INFO

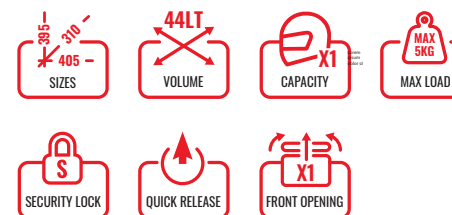

LARGE

58lt Cod. TC0011SN
535 x 395 x 310mm
Top case weight: 7,2 Kg



INFO

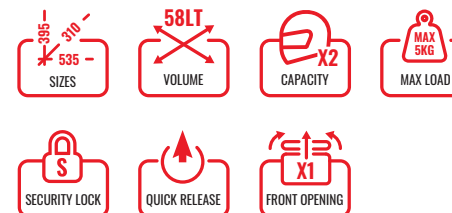

Grey Aluminum body ●

Black corners ●

OPTIONAL



Quick release Plate
*VARIABLE



Helmet cable
CAV099



Backrest
TC00S4



Mat
TA0044



Handles 44lt - 58lt
ASSC008 - ASSC009



Inner Bag expandible 33-55lt
BI0002



Inner Bag 44lt
BI0007 - BI007A



Inner Bag 58lt
BI0008 - BI008A

MODEL - X

Top case
Top cases



44lt

Model-x Small
44 Lt



58lt

Model-x Large
58 Lt



customize



aluminum



waterproof



lock system



push block



quick release

Specifiche tecniche / Technical specifications

SMALL

44lt Cod. TC0010NA
405 x 395 x 310mm
Top case weight: 6,2 Kg



INFO

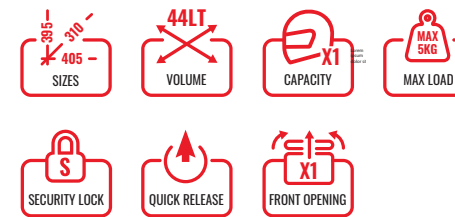

LARGE

58lt Cod. TC0011NA
535 x 395 x 310mm
Top case weight: 7,2 Kg



INFO

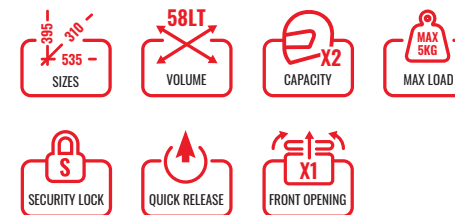

Black Aluminum body ●
Orange corners ●

OPTIONAL



Quick release Plate
*VARIABLE



Helmet cable
CAV099



Backrest
TC00S4



Mat
TA0044



Handles 44lt - 58lt
ASSC008 - ASSC009



Inner Bag expandible 33-55lt
BI0002



Inner Bag 44lt
BI0007 - BI007A



Inner Bag 58lt
BI0008 - BI008A

MODEL - X

Top case
Top cases



44lt

Model-x Small
44 Lt



58lt

Model-x Large
58 Lt



customize



aluminum



waterproof



lock system



push block



quick release

Specifiche tecniche / Technical specifications

SMALL

44lt Cod. TC0010SA
405 x 395 x 310mm
Top case weight: 6,2 Kg



INFO

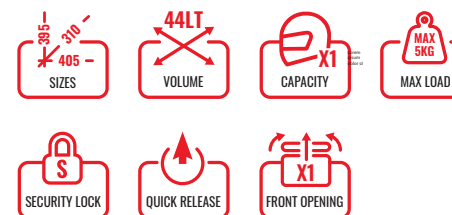

LARGE

58lt Cod. TC0011SA
535 x 395 x 310mm
Top case weight: 7,2 Kg



INFO

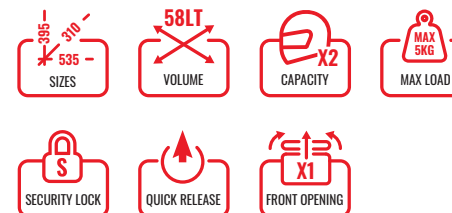

Grey Aluminum body ●

Orange corners ●

OPTIONAL



Quick release Plate
*VARIABLE



Helmet cable
CAV099



Backrest
TC00S4



Mat
TA0044



Handles 44lt - 58lt
ASSC008 - ASSC009



Inner Bag expandible 33-55lt
BI0002



Inner Bag 44lt
BI0007 - BI007A



Inner Bag 58lt
BI0008 - BI008A

MODEL - X

Top case
Top cases



44lt

Model-x Small
44 Lt



58lt

Model-x Large
58 Lt



customize



aluminum



waterproof



lock system



push block



quick release

Specifiche tecniche / Technical specifications

SMALL

44lt Cod. TC0010NR
405 x 395 x 310mm
Top case weight: 6,2 Kg

INFO

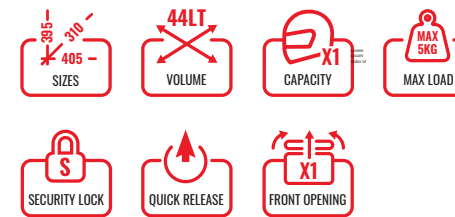

LARGE

58lt Cod. TC0011NR
535 x 395 x 310mm
Top case weight: 7,2 Kg

INFO

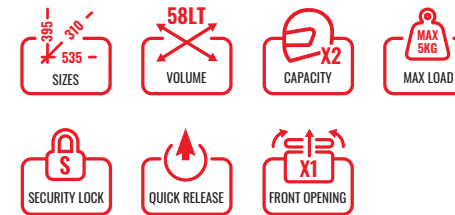

Black Aluminum body ●
Red corners ●

OPTIONAL



Quick release Plate
*VARIABLE



Helmet cable
CAV099



Backrest
TC00S4



Mat
TA0044



Handles 44lt - 58lt
ASSC008 - ASSC009



Inner Bag expandible 33-55lt
BI0002



Inner Bag 44lt
BI0007 - BI007A



Inner Bag 58lt
BI0008 - BI008A

MODEL - X

Top case
Top cases



44lt

Model-x Small
44 Lt



58lt

Model-x Large
58 Lt



customize



aluminum



waterproof



lock system



push block



quick release

Specifiche tecniche / Technical specifications

SMALL

44lt Cod. TC0010SR
405 x 395 x 310mm
Top case weight: 6,2 Kg



INFO

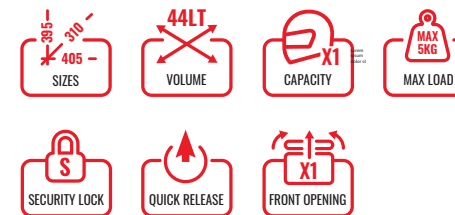

LARGE

58lt Cod. TC0011SR
535 x 395 x 310mm
Top case weight: 7,2 Kg



INFO

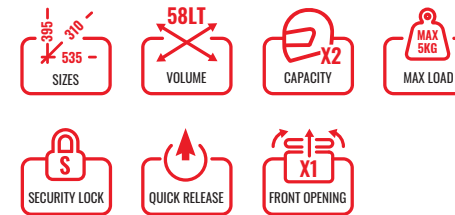

Grey Aluminum body ●
Red corners ●

OPTIONAL



Quick release Plate
*VARIABLE



Helmet cable
CAV099



Backrest
TC00S4



Mat
TA0044



Handles 44lt - 58lt
ASSC008 - ASSC009



Inner Bag expandible 33-55lt
BI0002



Inner Bag 44lt
BI0007 - BI007A



Inner Bag 58lt
BI0008 - BI008A

MODEL - X

Top case
Top cases



44lt

Model-x Small
44 Lt



58lt

Model-x Large
58 Lt



customize



aluminum



waterproof



lock system



push block



quick release

Specifiche tecniche / Technical specifications

SMALL

44lt Cod. TC0010NB
405 x 395 x 310mm
Top case weight: 6,2 Kg



INFO

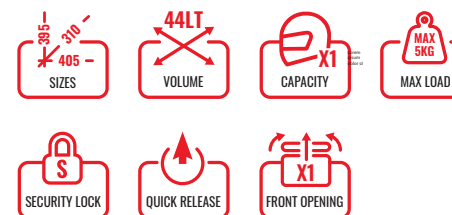

LARGE

58lt Cod. TC0011NB
535 x 395 x 310mm
Top case weight: 7,2 Kg



INFO

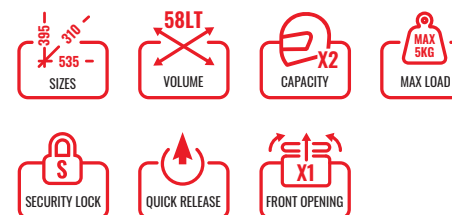

Black Aluminum body ●

Blue corners ●

OPTIONAL



Quick release Plate
*VARIABLE



Helmet cable
CAV099



Backrest
TC00S4



Mat
TA0044



Handles 44lt - 58lt
ASSC008 - ASSC009



Inner Bag expandible 33-55lt
BI0002



Inner Bag 44lt
BI0007 - BI007A



Inner Bag 58lt
BI0008 - BI008A

MODEL - X

Top case
Top cases



44lt

Model-x Small
44 Lt



58lt

Model-x Large
58 Lt



customize



aluminum



waterproof



lock system



push block



quick release

Specifiche tecniche / Technical specifications

SMALL

44lt Cod. TC0010SB
405 x 395 x 310mm
Top case weight: 6,2 Kg



INFO

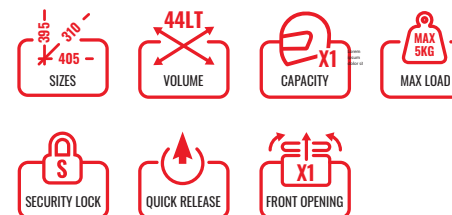

LARGE

58lt Cod. TC0011SB
535 x 395 x 310mm
Top case weight: 7,2 Kg



INFO

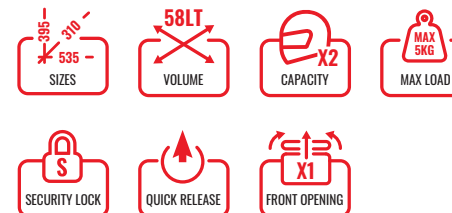

Grey Aluminum body ●

Blue corners ●

OPTIONAL ACCESSORI



Quick release Plate
*VARIABLE



Helmet cable
CAV099



Backrest
TC00S4



Mat
TA0044



Handles 44lt - 58lt
ASSC008 - ASSC009



Inner Bag expandible 33-55lt
BI0002



Inner Bag 44lt
BI0007 - BI007A



Inner Bag 58lt
BI0008 - BI008A



Cavo casco
Helmet cable



Schianalino
Backrest



Tappetino per 44lt
Mat for 44lt



SPARE PARTS MODEL - X RICAMBI



Corners 4pz red
ASSC0R



Corners 4pz orange
ASSC0A



Corners 4pz blue
ASSCOB



Corners 4pz black
ASSC0N



Hinge red
ASSC10R



Hinge orange
ASSC10A



Hinge blue
ASSC10B



Hinge black
ASSC10N



Handles 44lt
ASSC008



Handles 58lt
ASSC009



Strap hook
ASSC005



Rotor lock 2pz
ROT002X



Rotor lock 6pz
ROT006X



Rotor lock 9pz
ROT009X



MODEL - X RAW

Top case
Top cases



44lt

Model-x Small
44 Lt



58lt

Model-x Large
58 Lt



raw alu



waterproof



lock system



push block



quick release

Specifiche tecniche / Technical specifications

SMALL

44lt Cod. TC0012GN
405 x 395 x 310mm
Top case weight: 6,2 Kg



INFO

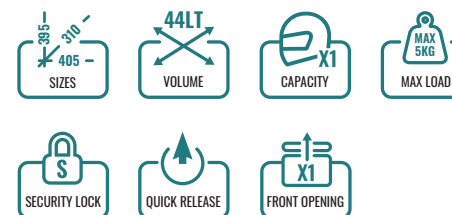

LARGE

58lt Cod. TC0013GN
535 x 395 x 310mm
Top case weight: 7,2 Kg



INFO

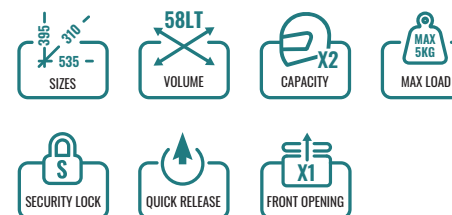

Raw Aluminum body

OPTIONAL ACCESSORI



Quick release Plate
*VARIABLE



Helmet cable
CAV099



Backrest
TC0054



Mat
TA0044



Inner Bag expandible 33-55lt
BI0002



Inner Bag 44lt
BI0007 - BI007A



Inner Bag 58lt
BI0008 - BI008A



Cavo casco
Helmet cable



Schianalino
Backrest



Tappetino per 44lt
Mat for 44lt



SPARE PARTS MODEL - XRAW RICAMBI



Hinge red
ASSC10R



Hinge orange
ASSC10A



Hinge blue
ASSC10B



Hinge black
ASSC10N



Strap hook
ASSC005



Rotor lock 2pz
ROT002X



Rotor lock 6pz
ROT006X



Rotor lock 9pz
ROT009X



La linea di valigie Model-x Raw può essere customizzata come vuoi tu con un wrapping high tech.

The Model-x Raw line of suitcases can be customized however you want with a high tech wrapping.



MODEL - X GSA

Top case
Top cases



44lt

Model-x Small
44 Lt



58lt

Model-x Large
58 Lt



aluminum



waterproof



lock system



push block



quick release

Specifiche tecniche / Technical specifications

SMALL

44lt Cod. TCGS10GN
405 x 395 x 310mm
Top case weight: 6,2 Kg



INFO

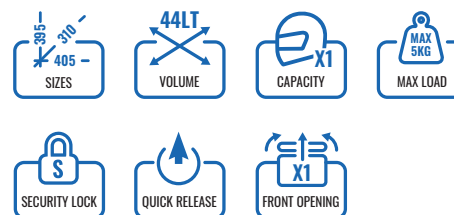

LARGE

58lt Cod. TCGS11GN
535 x 395 x 310mm
Top case weight: 7,2 Kg



INFO

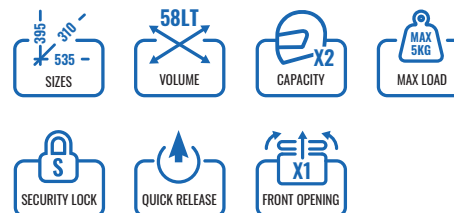

Raw or Black Aluminum body

Black Corners

OPTIONAL ACCESSORI



BMW Original Frames
*VARIABLE



Helmet cable
CAV099



Backrest
TC0054



Mat
TA0044



Handles 44lt - 58lt
ASSC008 - ASSC009



Inner Bag expandible 33-55lt
BI0002



Inner Bag 44lt
BI0007 - BI007A



Inner Bag 58lt
BI0008 - BI008A

MODEL - X GSA

Top case
Top cases

44lt



Model-x Small
44 Lt

58lt



Model-x Large
58 Lt



aluminum



waterproof



lock system



push block



quick release

Specifiche tecniche / Technical specifications

SMALL

44lt Cod. TCGS10NN
405 x 395 x 310mm
Top case weight: 6,2 Kg



INFO

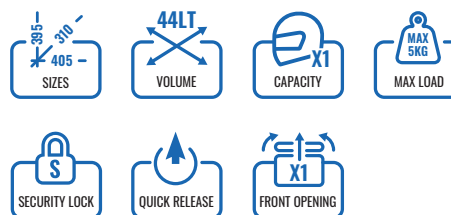

LARGE

58lt Cod. TCGS11NN
535 x 395 x 310mm
Top case weight: 7,2 Kg



INFO

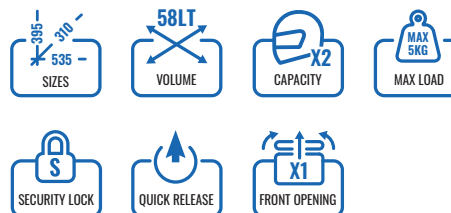

Black Aluminum body ●

Black corners ●

OPTIONAL



BMW Original Frames
*VARIABLE



Helmet cable
CAV099



Backrest
TC0054



Mat
TA0044



Handles 44lt - 58lt
ASSC008 - ASSC009



Inner Bag expandible 33-55lt
BI0002



Inner Bag 44lt
BI0007 - BI007A



Inner Bag 58lt
BI0008 - BI008A



Cavo casco
Helmet cable



Schianalino
Backrest



Tappetino per 44lt
Mat for 44lt



SPARE PARTS MODEL - X GSA RICAMBI



Corners 4pz red
ASSC0R



Corners 4pz orange
ASSC0A



Corners 4pz blue
ASSC0B



Corners 4pz black
ASSC0N



Hinge red
ASSC10R



Hinge orange
ASSC10A



Hinge blue
ASSC10B



Hinge black
ASSC10N



Handles 44lt
ASSC008



Handles 58lt
ASSC009



Strap hook
ASSC005



Rotor lock 2pz
ROT002X



Rotor lock 6pz
ROT006X



Rotor lock 9pz
ROT009X

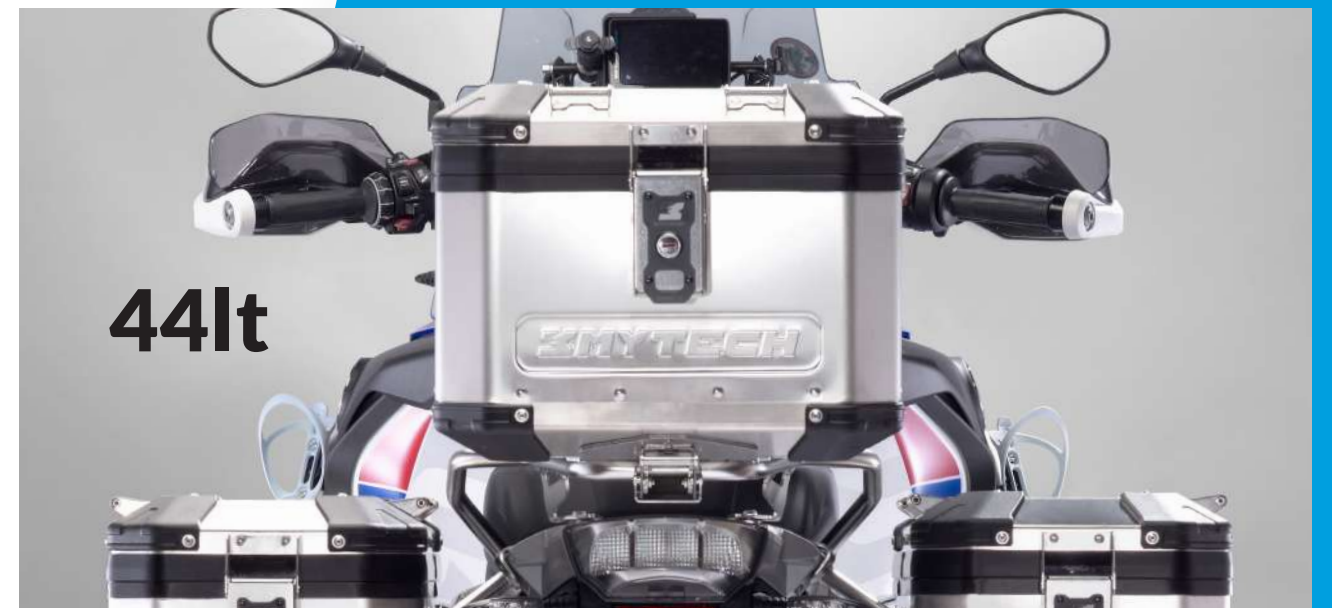

44lt

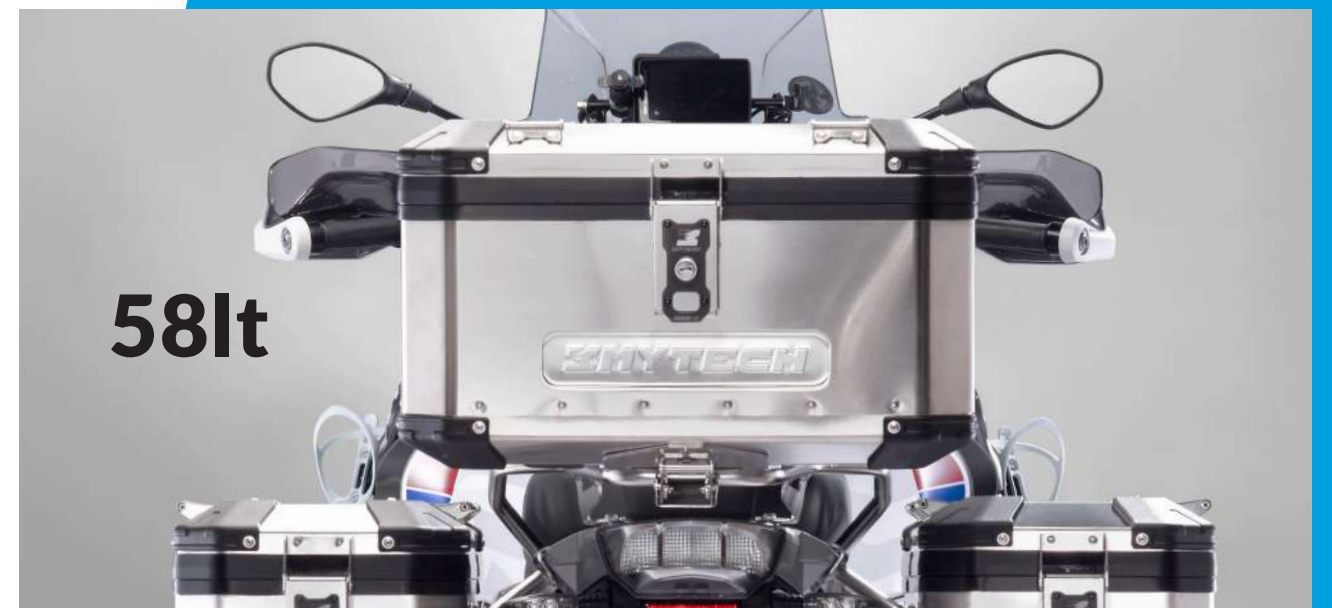

58lt

RAID PRO

Top case
Top cases



44lt

Raid Pro raw
44 Lt



44lt

Raid Pro black
58 Lt



aluminum



waterproof



lock system



push block



quick release

Specifiche tecniche / Technical specifications

RAW

44lt Cod. TC0014GN
433 x 448 x h333mm
Top case weight: 4,9 Kg



INFO



BLACK

44lt Cod. TC0014NN
433 x 448 x h333mm
Top case weight: 4,9 Kg



INFO



Raw Aluminum body

Black Corners

OPTIONAL

<p>Quick release Plate *VARIABLE</p>	<p>Helmet cable CAV099</p>	<p>Backrest TC00S4</p>	<p>Mat TA0044</p>
<p>Inner Bag expandible 33-55lt BI0002</p>	<p>Inner Bag 44lt BI0007 - BI007A</p>		



Cavo casco
Helmet cable



Schienalino
Backrest



Tappetino per 44lt
Mat for 44lt



SPARE PARTS RAID PRO RICAMBI

<p>Hinge red ASSC10R</p>	<p>Hinge orange ASSC10A</p>	<p>Hinge blue ASSC10B</p>	<p>Hinge black ASSC10N</p>
<p>X2 Rotor lock 2pz ROT002X</p>	<p>X6 Rotor lock 6pz ROT006X</p>	<p>X9 Rotor lock 9pz ROT009X</p>	



LIGHT



waterproof



abs



aluminum



fixed release

Il Top case Light, con coperchio in ABS è un giusto compromesso se non si vuole un prodotto totalmente in alluminio. Con una capacità di 60 litri può contenere fino a due caschi integrali o modulari. È disponibile in nero con apertura frontale.

The Mytech rear Top case model Light is a good compromise if you do not want to opt for a Top case totally in aluminum. With a capacity of 60 liters, it can hold up to two full-face or modular helmets. The top box is available in black with front opening.



ALU AND ABS

ABS COVER

COPERCHIO IN ABS

LIGHT

Top case
Top cases



Light
60lt

60lt



aluminum



abs



waterproof



fixed release

Specifiche tecniche / Technical specifications

Light



60lt Cod. TC0006N
380 x 520 x 300mm
Top case weight: 3,7 Kg

INFO

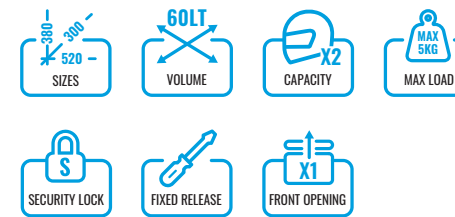

● Black

OPTIONAL ACCESSORI



Plate
*VARIABLE



Helmet cable
CAV099



Backrest
TC00S4



Inner Bag 58lt
BI0008 - BI008A



Inner Bag expandible 33-55lt
BI0002



Cavo casco
Helmet cable



Schienalino
Backrest



Alluminio e ABS
Alu and ABS



SPARE PARTS Light RICAMBI



Hinge
ASSC001



Rotor lock 1pz
ROT495R



Rotor lock 2pz
ROT195R



Rotor lock 4pz
ROT295R



Rotor lock 6pz
ROT695R



Rotor lock 7pz
ROT795R



RAID

Top case
Top cases

33lt



Raid Front Opening
33Lt



Raid Side Opening
33Lt



aluminum



waterproof



lock system



fixed release

Specifiche tecniche / Technical specifications



33lt

320 x 380 x 300mm

Top case weight: 5,6 Kg



INFO



FRONT
OPENING

33lt

Cod. TC0007SN

Bauletto Apertura frontale

Top case front Opening



SIDE
OPENING

33lt

Cod. TC0001SN

Bauletto Apertura laterale

Top case side Opening



FRONT
OPENING

33lt

Cod. TC0007NS

Bauletto Apertura frontale

Top case front Opening



SIDE
OPENING

33lt

Cod. TC0001NS

Bauletto Apertura laterale

Top case side Opening



Black or grey Aluminum body



Black or grey corners



OPTIONAL



Plate

*VARIABLE



Helmet cable

CAV099



Backrest

TC00S4



Mat

TA0044



Handles

ASSC003



Inner Bag expandible 33-55lt

BI0002

RAID

Top case
Top cases

41lt



Raid Front Opening
41 Lt



Raid Side Opening
41 Lt



aluminum



waterproof



lock system



fixed release

Specifiche tecniche / Technical specifications



41lt

350 x 420 x 300mm.

Top case weight: 5,6 Kg



INFO



FRONT
OPENING

41lt

Cod. TC0008SN

Bauletto Apertura frontale

Top case front Opening



SIDE
OPENING

41lt

Cod. TC0005SN

Bauletto Apertura laterale

Top case side Opening

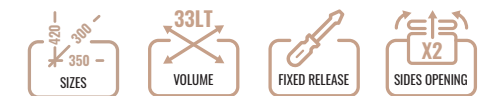

FRONT
OPENING

41lt

Cod. TC0008NS

Bauletto Apertura frontale

Top case front Opening



SIDE
OPENING

41lt

Cod. TC0005NS

Bauletto Apertura laterale

Top case side Opening

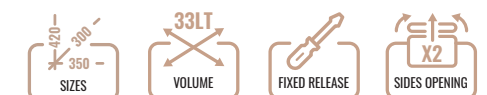

Black or grey Aluminum body



Black or grey corners



OPTIONAL ACCESSORI



Plate

*VARIABLE



Helmet cable

CAV099



Backrest

TC00S4



Mat

TA0044



Handles

ASSC003



Inner Bag expandible 33-55lt

BI0002

RAID

Top case
Top cases

55lt



Raid Front Opening
41 Lt



Raid Side Opening
41 Lt

55lt



aluminum



waterproof



lock system



fixed release

Specifiche tecniche / Technical specifications



55lt

300 x 520 x 380mm

Top case weight: 5,6 Kg



INFO



**FRONT
OPENING**

55lt

Cod. TC0009SN

Bauletto Apertura frontale

Top case front Opening



**SIDE
OPENING**

55lt

Cod. TC0003SN

Bauletto Apertura laterale

Top case side Opening

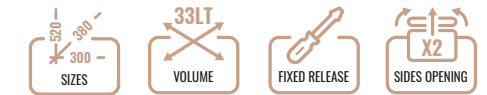

**FRONT
OPENING**

55lt

Cod. TC0009NS

Bauletto Apertura frontale

Top case front Opening



**SIDE
OPENING**

55lt

Cod. TC0003NS

Bauletto Apertura laterale

Top case side Opening

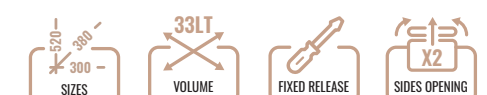

Black or grey Aluminum body



Black or grey corners



OPTIONAL



Plate

*VARIABLE



Helmet cable

CAV099



Backrest

TC00S4



Mat

TA0044



Handles

ASSC003



Inner Bag expandible 33-55lt

BI0002



Cavo casco
Helmet cable











Schianalino
Backrest



Tappetino per 41lt
Mat for 41lt



SPARE PARTS Raid RICAMBI

 Hinge ASSC001	 Strap hook ASSC002	 Handles ASSC003	 Rotor lock 1pz ROT495R
 Rotor lock 2pz ROT195R	 Rotor lock 4pz ROT295R	 Rotor lock 6pz ROT695R	 Rotor lock 7pz ROT795R



BORSE INTERNE

Soft inner bags

174 / BORSA INTERNA PICCOLA | Inner bag Small

175 / BORSA INTERNA GRANDE | Inner bag large

176 / BORSA INTERNA BAULETTO | Inner bag Top cases

177 / BORSA INTERNA Raid | Inner bag Raid

BORSE ESTERNE

Soft outer bags

178 / BORSA ESTERNA | Outer bag

180 / SOFT-X TOP BAG | Outer bag



BORSE

Soft bags



waterproof



light

Comode, pratiche, indispensabili in viaggio: Mytech propone borse morbide interne ed esterne studiate appositamente per adattarsi ai diversi modelli di valigie rigide da moto. Le borse interne possono essere comodamente estratte e permettono ai motociclisti di portarle con sé, senza dover necessariamente sganciare la valigia dalla moto.

Comfortable, practical, essential when traveling: Mytech offers soft internal and external bags specifically designed to adapt to the different models of rigid motorcycle suitcases. The inner bags can be easily extracted and allow motorcyclists to take them with them, without necessarily having to unhook the suitcase from the motorcycle.



BORSE INTERNE

Inner soft bags

Model-x - SL
Compatibility



32lt

Borsa interna
Inner bag

Cod. BI0009 - BI009A



Black or orange

Model-x - SL
Compatibility



39lt

Borsa interna
Inner bag

Cod. BI0010 - BI010A



Black or orange



41lt

Borsa interna
Inner bag

Cod. BI0011 - BI011A



Model-x - SL
Compatibility

Black or orange



48lt

Borsa interna
Inner bag

Cod. BI00012 - BI0012A



Model-x - SL
Compatibility

Black or orange

BORSE INTERNE

Inner soft bags

Model-x - SL
Compatibility



44lt

Borsa interna
Inner bag

Cod. BI0007 - BI007A



Black or orange



58lt

Borsa interna
Inner bag

Cod. BI0008 - BI008A

Black or orange

Model-x - SL
Compatibility

Model-x - SL - Raid
Compatibility



33-55lt

Borsa interna
Inner bag

Cod. BI0002



Black



47lt

Borsa interna
Inner bag

Cod. BI0001

Black

Model-x - SL - Raid
Compatibility

BORSA ESTERNA

Outer soft bag

Model-x - Raid
Compatibility



10lt

Borsa esterna
Outer bag

Cod. BI0004



Protezione esterna integrata.
Integrated external protection.

Banda catarifrangente.
Reflective band.



SOFT-X TOP BAG

SOFT-X Top Bag

60lt



SOFT-X Top bag
60Lt



aluminum



pes



tpu



waterproof



lock system



push block



quick release

Specifiche tecniche / Technical specifications

TOP BAG SOFT-X



60lt Cod. SX0060SN
600 x 320 x 360mm
Top bag weight: 0,8 Kg



INFO

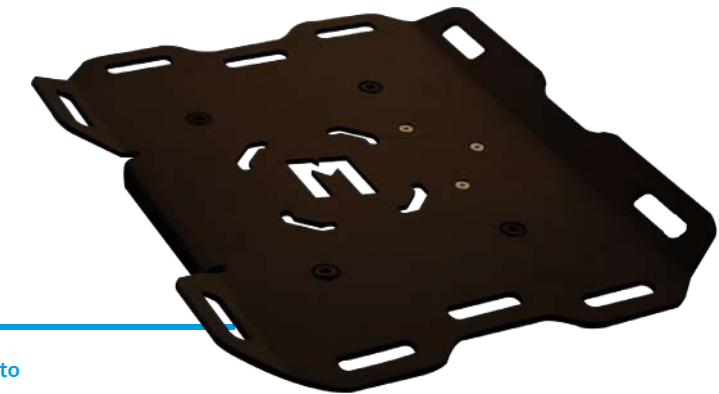
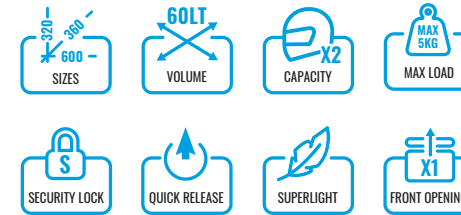

Pag 192 Piastra portatutto
Pag 192 Roof plate



Pag 88 Soft-x Side Bag
Pag 88 Soft-x Side Bag

Polyester and TPU

ACCESSORI

Accessories

- 184 / CASSETTA ATTREZZI | Tool case
- 188 / CASSETTA MANUBRIO | Handle box
- 192 / PIASTRA PORTATUTTO | Roof plate
- 194 / CARRELLO ACCOSTAMOTO | Motorcycle Dolly



CASSETTA ATTREZZI

Tool Case



waterproof



aluminum



fixed release

L'accessorio più amato dai motociclisti. Nato per attrezzi, medicinali, guanti o per riporvi documenti. Il tool case è saldato internamente e ha al suo interno una guarnizione per renderlo perfettamente a tenuta d'acqua. Può essere installato sui telai originali o con i telaietti laterali Mytech. Disponibile in nero o grigio, verniciato a polvere.

The accessory most loved by motorcyclists. Born for tools, medicines, gloves or for storing documents. The tool case is welded internally and has a gasket inside to make it perfectly watertight. It can be installed on the original frames or with the Mytech side frames. Available in black or grey, powder coated.



CASSETTA ATTREZZI

Tool Case



2,3Lt

Porta attrezzi
Tool case

Cod * Variable



Black ●



3,2Lt

Porta attrezzi
Tool case

Cod * Variable



Black ●



2,3Lt

Porta attrezzi
Tool case

Cod * Variable



Grey ●



3,2Lt

Porta attrezzi
Tool case

Cod * Variable



Grey ●



CASSETTA MANUBRIO

Handle Box



waterproof



aluminum



fixed release

Handle Box è la semplice ed efficace soluzione sul manubrio per contenere piccoli oggetti come cellulare, telepass, portafoglio, monete, caricabatterie, occhiali o altro, sempre facilmente raggiungibili.

Handle Box is the simple and effective solution on the handlebar to hold small objects such as mobile phone, telepass, wallet, coins, charger, glasses or other, always within easy reach.



CASSETTA MANUBRIO

Handle Box

Black ●



Large

Porta accessori
Handle box

Cod * Variable



Grey ●



Large

Porta accessori
Handle box

Cod * Variable

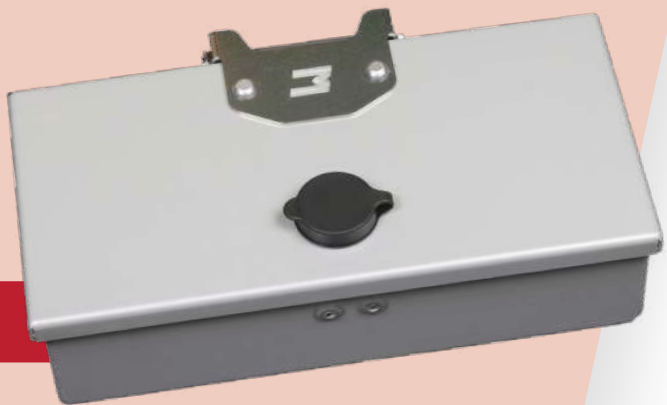

Black ●



Small

Porta accessori
Handle box

Cod * Variable



PIASTRA PORTATUTTO

Roof plate



waterproof



aluminum



push block

Black ●
Cod PPT020PB

Indeciso se fissare un bauletto o un borsone morbido alla tua moto? Con questa piastra portatutto a sgancio rapido puoi risolvere il problema passando in brevissimo tempo da uno all'altro. Tutto grazie al nostro aggancio Push Block. La piastra è prodotta con taglio laser e verniciata a polvere nera al fine di ottenere una maggior protezione agli agenti atmosferici.

Undecided whether to attach a Top case or a soft bag to your motorcycle? With this quick release roof plate you can solve the problem by switching from one to the other in a very short time. All thanks to our Push Block coupling. The plate is produced with laser cutting and black powder coated in order to obtain greater protection against atmospheric agents.



CARRELLO ACCOSTAMOTO

Motorcycle Dolly



aluminum

Black ●

Cod AX0101N

Carrello accostamoto, la soluzione migliore per spostare la tua moto con facilità. Dotato di quattro ruote, di cui due con fermo per facilitare gli spostamenti della moto nel tuo garage e per bloccarne lo spostamento una volta riposta. Realizzato in acciaio, spessore 6mm, verniciato nero.

Side-by-side trolley, the best solution to move your bike with ease. Equipped with four wheels, two of which with stops to facilitate the movement of the motorcycle in your garage and to block its movement once stored. Made of steel, 6mm thick, painted black.



MYTEC
www.mytechaccessories.it

PROTEZIONI

Protections

198 / PROTEZIONI

| *Protections*

218 / PROTEZIONE MOTORE

| *Sump guard*



PROTEZIONI

Protections



waterproof



customize



aluminum



abs

Vasta gamma di protezioni in alluminio anodizzato disponibile in diverse colorazioni per più di 80 modelli di moto.

Wide range of aluminum protections anodized available in different colors for more than 80 motorcycle models.

In caso di uso in fuoristrada e per proteggere da pietrisco e cadute le nostre protezioni offrono sicurezza aggiuntiva al conducente e ai componenti importanti della moto.

In case of off-road use and to protect against stone chips and falls, our protections offer additional safety to the driver or to the important components of the motorcycle.



PROTEZIONE FARETTI

Spotlights
protection

Protegge da sassi ed agenti esterni. Progettata per integrarsi al meglio con la linea della tua moto. Alluminio anodizzato disponibile in cinque colori.

Protects from stones and external agents. Designed to best integrate with the line of your bike. Anodized aluminum available in five colors.

KTM | BMW |



MASCHERA GRIGLIA FARO

Headlight
protection

Protegge il faro della vostra moto da sassi e colpi. Alluminio anodizzato 3mm.

Protects the headLight of your motorcycle from stones and blows. 3mm anodized aluminum.

TRIUMPH | BMW | HONDA | KTM | YAMAHA | MOTO GUZZI |

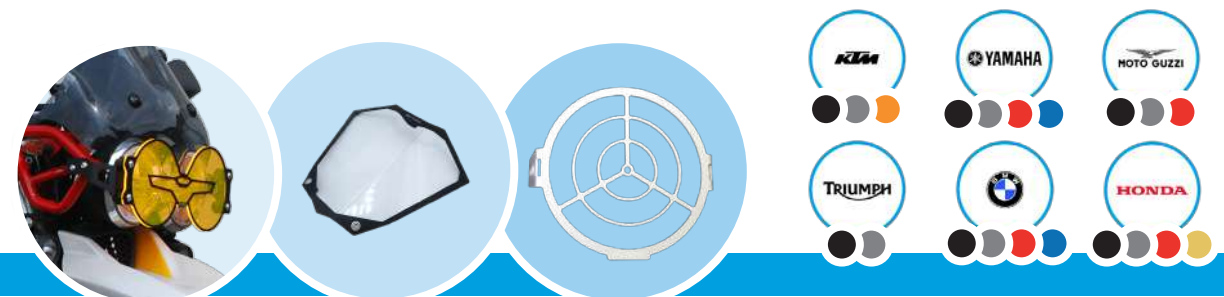

PROTEZIONE LEVERAGGIO FRIZIONE

Clutch linkage protection

Protegge leva e filo frizione da eventuali colpi, con un'estetica aggressiva.

It protects the lever and clutch wire from any blows, with an aggressive aesthetic.

HONDA | YAMAHA |



SERBATOIO OLIO FRENO ANTERIORE

Front brake oil reservoir

In alluminio anodizzato, impedisce il danneggiamento o la manomissione del tappo del serbatoio.

Made of anodized aluminum, it prevents the tank cap from being damaged or tampered with.

BMW | DUCATI | HARLEY DAVIDSON | KTM | TRIUMPH |



SERBATOIO OLIO FRIZIONE ANTERIORE

Clutch brake fluid reservoir

Protegge il tappo del serbatoio dell'olio da svitamenti accidentali migliorando l'estetica della moto.

Protects the oil tank cap from accidental unscrewing, improving the aesthetics of the bike.

BMW | TRIUMPH |



COPERTURA RADIATORE OLIO

Coverage radiator

Per preservarne l'integrità del radiatore evitando l'impatto con sassi o altro. In lega di alluminio mm. 2,5.

To preserve the integrity of the radiator by avoiding the impact with stones or other. In aluminum alloy mm. 2.5.

BMW | HONDA | MOTO GUZZI | TRIUMPH | SUZUKI |

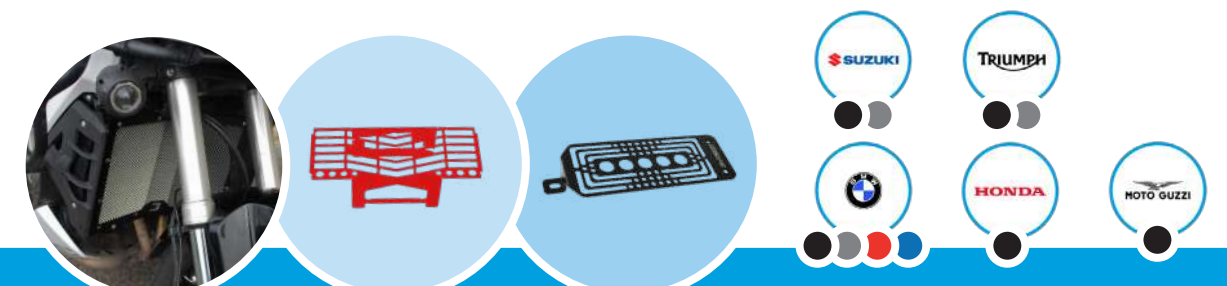

PROTEZIONE FIANCHETTO

Side pan protection

La protezione fianchetto protegge da eventuali colpi o rami in utilizzo off-road.

The side panel protection protects against any bumps or branches in off-road use.

BMW | KTM | YAMAHA | HUSQVARNA | MOTO GUZZI |

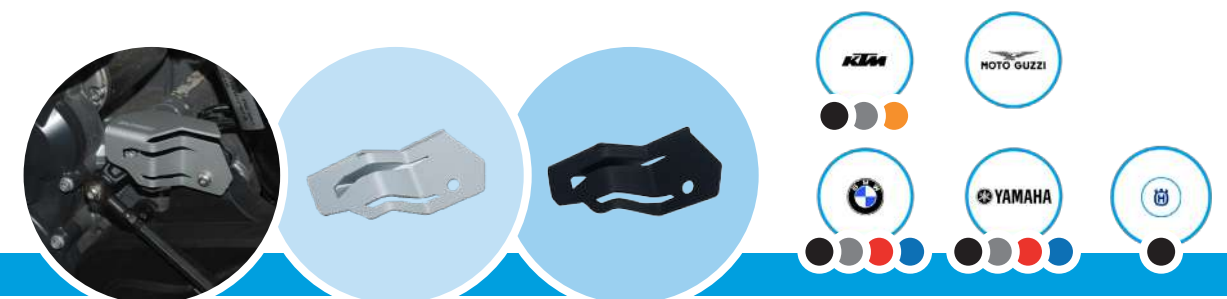

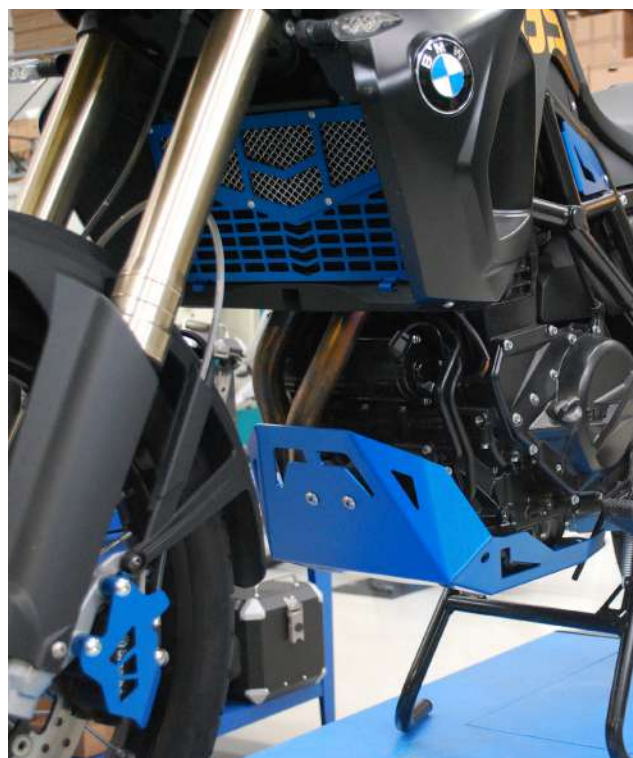

**PROTEZIONE
(X2) CORPI
FARFALLATI**

Throttle bodies
protection

Proteggono la zona dei cavi elettrici e del tubo della benzina evitando possibili distaccamenti.

They protect the area of electric cables and the petrol pipe avoiding possible detachments.

MOTO GUZZI | BMW



**BILANCERI
MANUBRIO**

Pair of rockers
handlebar

Progettati sia per proteggere le parti più esposte, sia per dare un aspetto più completo e aggressivo.

Designed both to protect the most exposed parts, and to give a more complete and aggressive look.

TRIUMPH |



**PROTEZIONE (X2)
CILINDRI
ANODIZZATI**

anodized cylinders
protection

Efficace per proteggere i coperchi dei cilindri in caso di caduta o rovesciamento accidentale della moto.

Effective to protect the cylinder covers in case of accidental fall or overturning of the motorcycle.

BMW |



PROTEZIONE (X2) PINZE

(X2) Pliers protection

Protegge le pinze durante il fuoristrada o in caso di cadute accidentali.

Protects the calipers during off-roading or in the event of accidental falls.

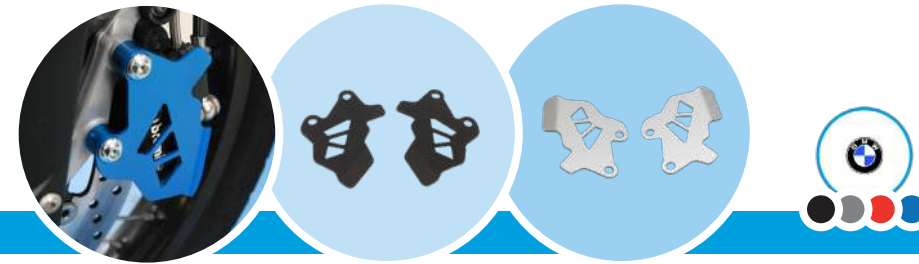

BMW |

PROTEZIONE POTENZIOMETRO

Potentiometer
protection

Protegge lo spinotto in plastica da rotture causate da colpi in fase di salita o da usura soprattutto per chi utilizza stivali da enduro.

Protects the plastic pin from breakage caused by blows given when climbing on the bike or by wear of the plastic especially for those who use enduro boots.

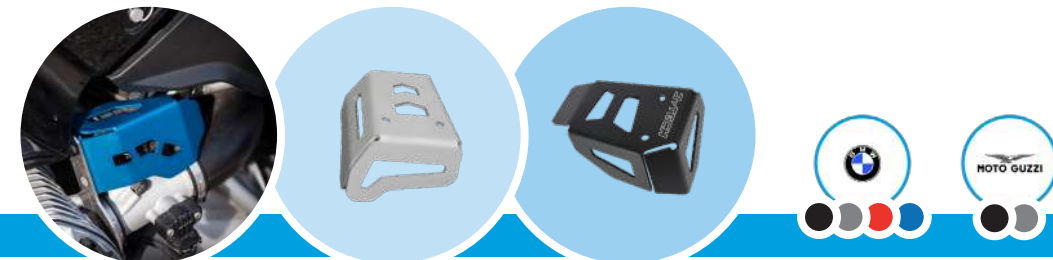

BMW | MOTO GUZZI |



ALLARGAMENTO PEDANA FRENO

Extension of
the brake platform

Migliora la sicurezza offrendo una superficie di appoggio più ampia e una pressione sicura sulla leva del freno. Realizzato in acciaio inox.

Enhance safety by offering a larger footprint and secure pressure on the brake lever. Made of stainless steel.

HONDA | HUSQVARNA | KTM | YAMAHA |



ALLARGAMENTO PIASTRA CAVALLETTO

Stand
enlargement Plate

In alluminio anodizzato, è utile per allargare la superficie di appoggio del cavalletto laterale originale evitando cadute accidentali della moto.

In anodized aluminum, it is useful for widening the support surface of the original side stand, avoiding accidental falls of the bike.

SUZUKI | TRIUMPH | BENELLI | DUCATI | HARLEY DAVIDSON | MOTO GUZZI |
HONDA | KTM |



ESTENSIONE LEVA DEL CAMBIO

Gear lever
extension

Leva da sostituire all'originale, migliora la sicurezza e l'ergonomia nei pedali del cambio. Alluminio con fresatura CNC.

Lever to replace the original, improves safety and ergonomics in the gearshift pedals. Aluminum with CNC milling.

KTM | HARLEY DAVIDSON |



PROTEZIONE (X2) PARATACCO ANODIZZATO

Heel guard protection

Lega di alluminio spessore mm. 2,5 sostituisce l'originale in plastica di serie, proteggendo dal contatto.

Aluminum alloy thickness mm. 2.5 replaces the original standard plastic, protecting against contact.

BMW | HARLEY DAVIDSON | YAMAHA |

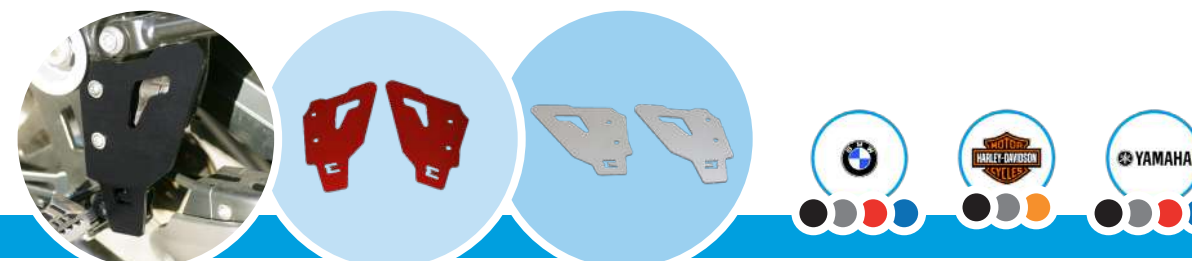

PROTEZIONE POMPA FRENO

Brake pump protection

Protegge la pompa freno da eventuali danni, soprattutto in off road.

Protects the master cylinder from damage, especially off road.

BMW | HUSQVARNA | KTM | YAMAHA | HARLEY DAVIDSON |



PROTEZIONE POMPA ACQUA

Water pump protection

Protegge la pompa acqua da eventuali danni, soprattutto in off road.

Protects the water pump from damage, especially off road.

YAMAHA |

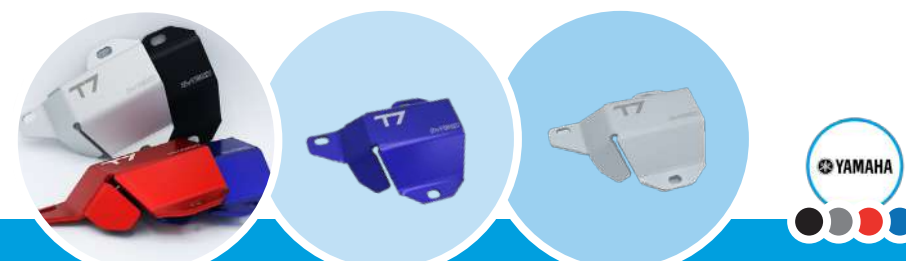

SERBATOIO OLIO FRENO POSTERIOORE

Rear brake oil reservoir

In alluminio anodizzato, impedisce il danneggiamento o la manomissione del tappo del serbatoio.

Made of anodized aluminum, it prevents the tank cap from being damaged or tampered with.

BMW | BENELLI | MOTO GUZZI | TRIUMPH | MOTO MORINI | HUSQVARNA | KTM | SUZUKI | YAMAHA |



COVER SENSORE ABS

ABS sensor cover

La protezione sensore ABS protegge il sensore freno da eventuali danni in off road.

The ABS sensor guard protects the brake sensor from damage off road.

HUSQVARNA | KTM | BMW | HONDA |



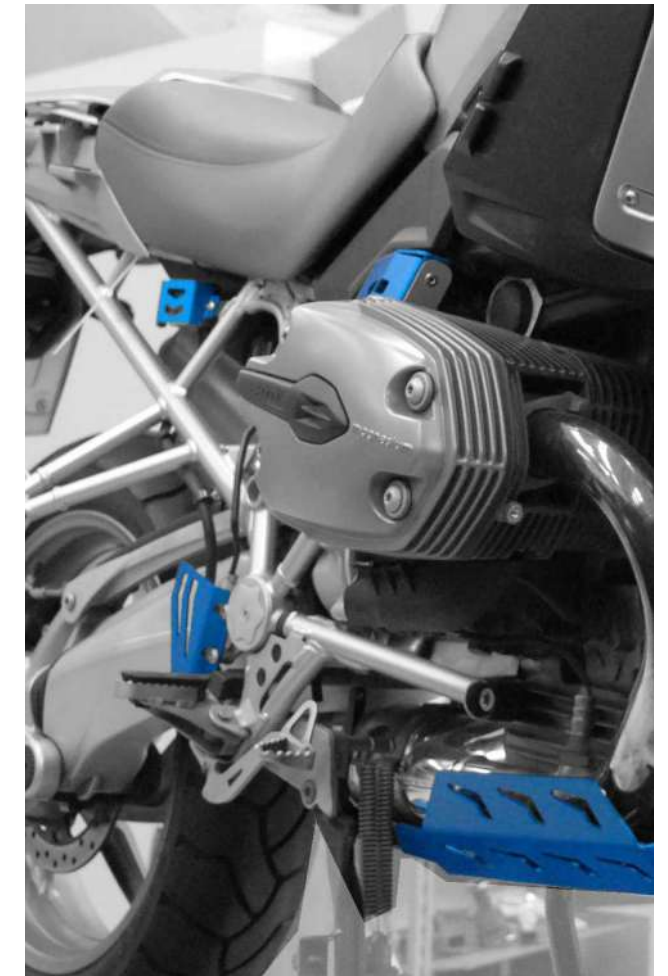

PROTEZIONE COPRISCARICO

Throttle bodies protection

Questa protezione permette di proteggersi da eventuali scottature con il silenziatore.

This protection allows you to protect yourself from possible burns with the silencer.

BMW | MOTO GUZZI | SUZUKI |

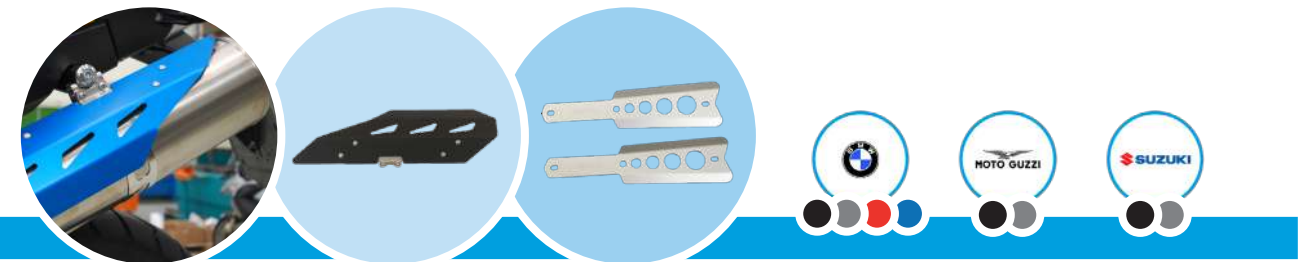

PROTEZIONE CATENA

Chain guard

La protezione catena evita il contatto diretto con la catena di trasmissione.

The chain guard avoids direct contact with the drive chain.

BMW | HONDA | YAMAHA | KTM |



PIASTRA PARAFANGO

Fender plate

Di facile e comodo utilizzo per fissare ulteriori borse morbide sia sopra che sotto il codone della moto utilizzando le asole presenti sulla piastra.

Easy and comfortable to use to fix additional soft bags both above and below the motorcycle tail using the slots on the plate.

YAMAHA |

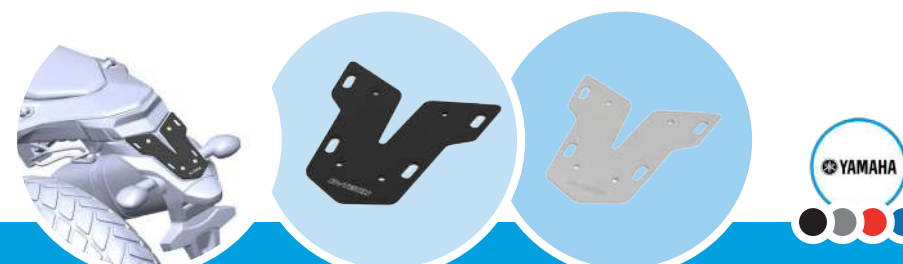

PROTEZIONE PINNA CATENA

Chain
fin protection

In acciaio Inox ed alluminio anodizzato. Protegge la moto dai rami che si possono incastrare tra la catena e la corona.

In stainless steel and anodized aluminum. Protects the bike from branches that can get stuck between the chain and the crown.

HONDA | DUCATI | HARLEY DAVIDSON | KTM | YAMAHA |



PROTEZIONE CARDANO

Cardan
protection

Protegge il cardano da cadute accidentali della moto o da possibili colpi.

Protects the cardan from accidental falls of the motorcycle or from possible blows.

MOTO GUZZI |



PROTEZIONE REGOLATORE DI TENSIONE

Voltage regulator
protection

Protegge da danni provocati da sassi o agenti esterni.

Protects from damage caused by stones or external agents.

BMW | MOTO GUZZI | HONDA | TRIUMPH | HARLEY DAVIDSON | DUCATI |

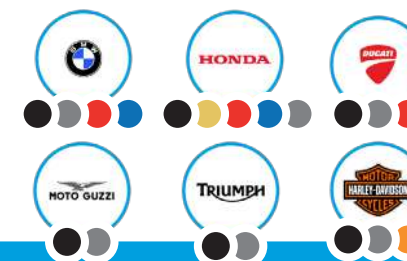
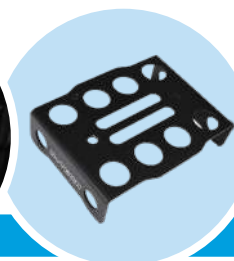

PROTEZIONE TUBOLARI POSTERIORI

Rear tubular
protection

Le barre proteggono le parti posteriori della moto in caso di caduta.

The bars protect the rear parts of the bike in the event of a fall.

BMW | YAMAHA |



PROTEZIONE MOTORE

Sump guard protection



waterproof



customize



aluminum

Le protezioni per il motore sono realizzate completamente in alluminio in diversi spessori. Progettate per integrarsi al meglio con la linea della vostra moto.

The sump guards are made entirely of aluminum in different thicknesses. Designed to best integrate with the line of your bike.

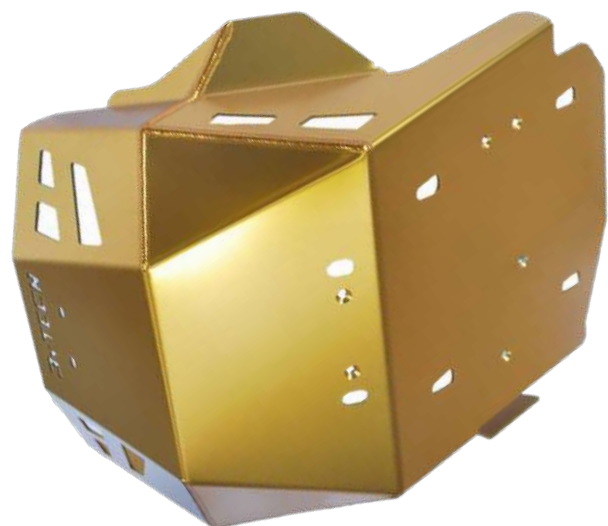

Raw Aluminum ●



Protezione motore
Sump guard

Cod * Variable

Black ●

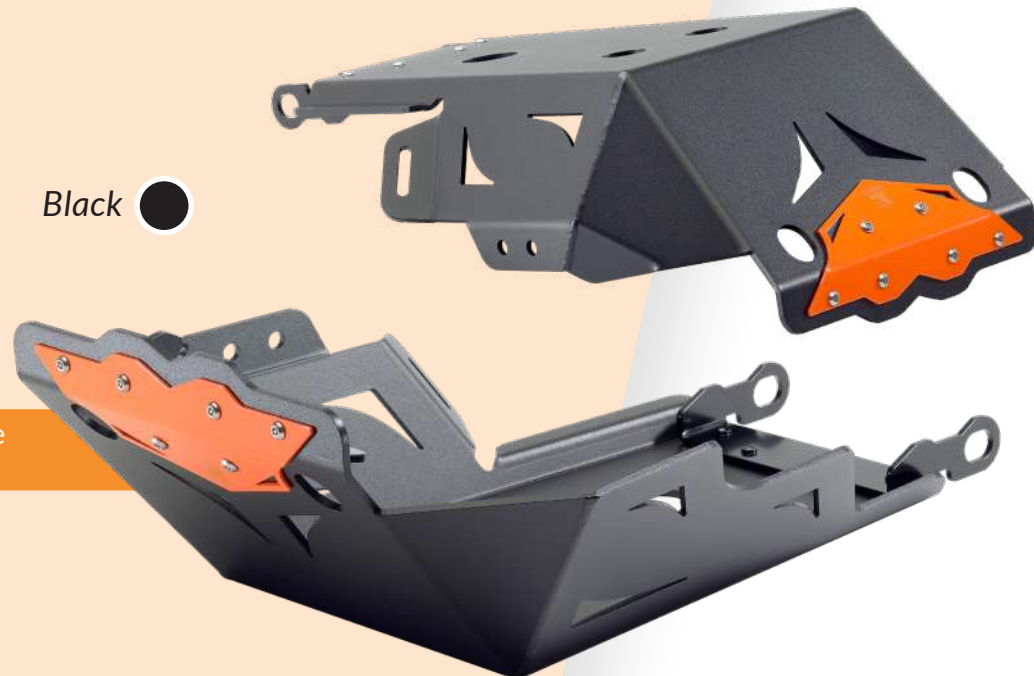

Protezione motore
Sump guard

Cod * Variable

Black ●



Protezione motore
Sump guard

Cod * Variable



Protezione motore
Sump guard

Cod * Variable

Raw Aluminum ●

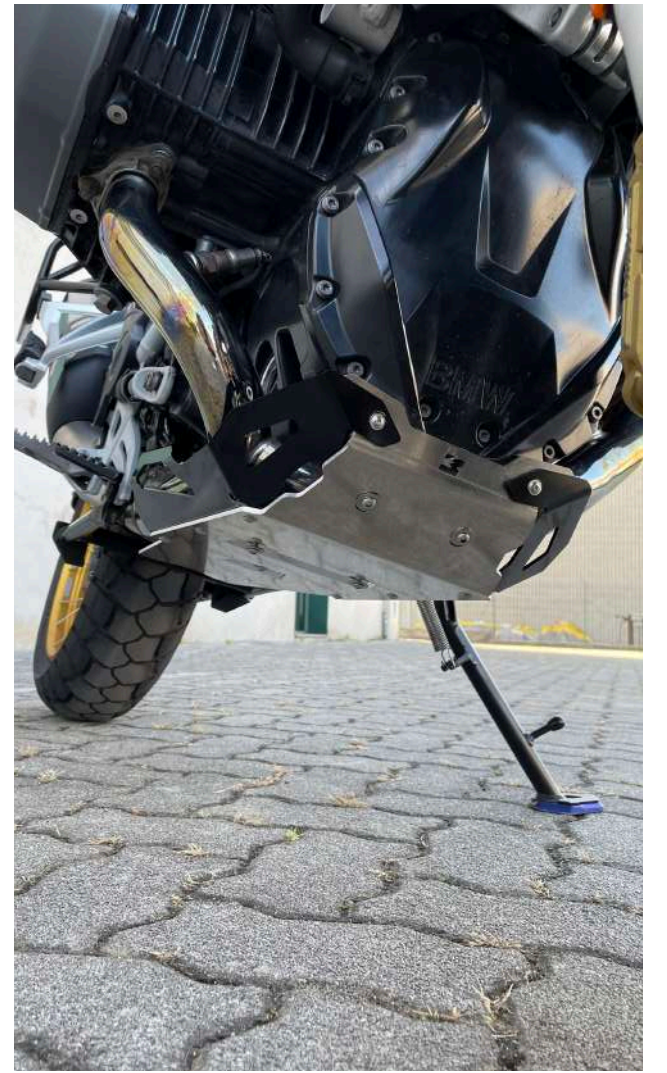
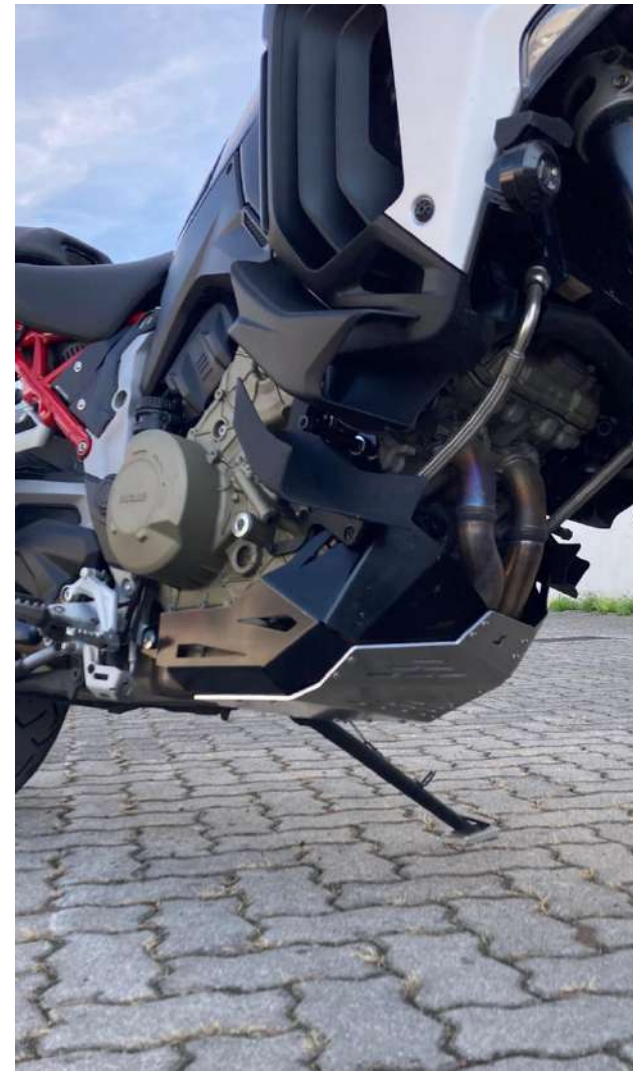

ESPOSITORI

Advertising display stand

Espositore per kit protezioni con telaio in ferro e ganci rimovibili a seconda delle vostre esigenze.

Espositori per kit di valigie disponibili in due versioni, grande e piccolo con attacchi Push block.

Display panel for protection kits with iron frame and removable hooks according to your needs.

Display units for suitcase kits available in two versions, large and small with Push block attachments.



Totem

200x100 cm

Espositore protezioni
Protections display panel

Cod. ESPPRO