

VALIGIE LATERALI

Side Panniers

60 / SUPERLEGGERA

64 / MODEL - X

82 / MODEL - X RAW

86 / MODEL - X GSA

90 / RAID

108 / RAID GSA

112 / SMART TANK



VALIGIE LATERALI Side Panniers

Superleggera



Valigia in alluminio e carbonio
40Lt - 47Lt

pag. 60

MODEL-X



Valigia in alluminio
32Lt - 39Lt / 41Lt - 48Lt

pag. 64

MODEL-X



Valigia in alluminio
32Lt - 39Lt / 41Lt - 48Lt

pag. 66

MODEL-X RAW



Valigia in alluminio
32Lt - 39Lt / 41Lt - 48Lt

pag. 82

MODEL-X GSA



Valigia in alluminio
41Lt - 48Lt

pag. 86

MODEL-X GSA



Valigia in alluminio
41Lt - 48Lt

pag. 86

MODEL-X



Valigia in alluminio
32Lt - 39Lt / 41Lt - 48Lt

pag. 68

MODEL-X



Valigia in alluminio
32Lt - 39Lt / 41Lt - 48Lt

pag. 70

MODEL-X



Valigia in alluminio
32Lt - 39Lt / 41Lt - 48Lt

pag. 72

Raid



Valigia in alluminio
33Lt - 39Lt / 41Lt - 47Lt

pag. 90

Raid



Valigia in alluminio
33Lt - 39Lt / 41Lt - 47Lt

pag. 94

Raid



Valigia in alluminio
39Lt - 39Lt / 47Lt - 47Lt

pag. 98

MODEL-X



Valigia in alluminio
32Lt - 39Lt / 41Lt - 48Lt

pag. 74

MODEL-X



Valigia in alluminio
32Lt - 39Lt / 41Lt - 48Lt

pag. 76

MODEL-X



Valigia in alluminio
32Lt - 39Lt / 41Lt - 48Lt

pag. 78

Raid



Valigia in alluminio
39Lt - 39Lt / 47Lt - 47Lt

pag. 102

Raid GSA



Valigia in alluminio
41Lt - 47Lt

pag. 108

Raid GSA



Valigia in alluminio
41Lt - 47Lt

pag. 108

Superleggera

Valigie laterali
Side suitcase

40 - 47lt



Superleggera
40-47 Lt



superlight



aluminum



carbon



waterproof



lock system



push block

Specifiche tecniche / Technical specifications

Superleggera

40lt Cod. VS0017
481.5x 245 x391.3mm
Weight: 3,8 Kg

47lt Cod. VD0017
481.5x 245 x391.3mm
Weight: 3,8 Kg

INFO

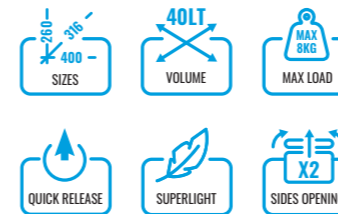

INFO

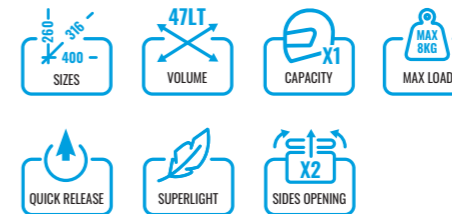

Aluminum and Carbon



OPTIONAL ACCESSORI



Superleggera Frames
*VARIABLE



Helmet cable
CAV099



Inner Bag 41lt
BI0011 - BI011A



Inner Bag 48lt
BI0012 - BI012A



Cavo casco
Helmet cable

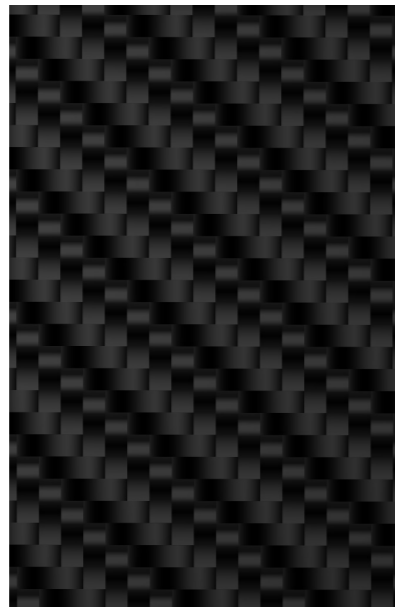

Fibra di carbonio - 44% Peso
Carbon fiber - 44% Weight



Dettagli
Details



SPARE PARTS Superleggera RICAMBI



Hinge black
ASSC10N



X2
Rotor lock 2pz
ROT002X



X6
Rotor lock 6pz
ROT006X



X9
Rotor lock 9pz
ROT009X



MODEL - X

Valigie laterali
Side suitcase



32 - 39lt

Model-x Small
32 - 39Lt



41 - 48lt

Model-x Large
41 - 48Lt



customize



aluminum



waterproof



lock system



push block

Specifiche tecniche / Technical specifications

SMALL

32lt Cod. VS0008
481.5x 245 x391.3mm
Weight: 6 Kg

39lt Cod. VD0008
481.5x 245 x391.3mm
Weight: 6,3 Kg

INFO

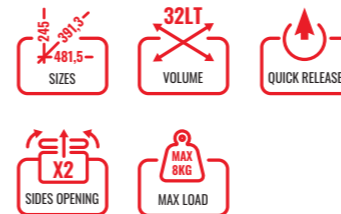

INFO



LARGE

41lt Cod. VS0007
481.5x 289 x391.3mm
Weight: 6,5 Kg

48lt Cod. VD0007
481.5x 289 x391.3mm
Weight: 6,8 Kg

INFO



INFO



Black Aluminum body ●

Black corners ●

OPTIONAL



Model-x Frames
*VARIABLE



Helmet cable
CAV099



Outer Bag 15lt
BI0004



Handles 32/39lt 41/48lt
ASSC006 - ASSC007



Inner Bag 32lt
BI0009 - BI009A



Inner Bag 39lt
BI0010 - BI010A



Inner Bag 41lt
BI0011 - BI011A



Inner Bag 48lt
BI0012 - BI012A

MODEL - X

Valigie laterali
Side suitcase



32 - 39lt

Model-x Small
32 - 39Lt



41 - 48lt

Model-x Large
41 - 48Lt



customize



aluminum



waterproof



lock system



push block

Specifiche tecniche / Technical specifications

SMALL

32lt Cod. VS008S
481.5x 245 x391.3mm
Weight: 6 Kg

39lt Cod. VD008S
481.5x 245 x391.3mm
Weight: 6,3 Kg

INFO

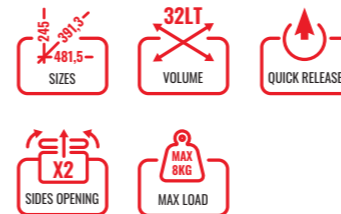

INFO



LARGE

41lt Cod. VS007S
481.5x 289 x391.3mm
Weight: 6,5 Kg

48lt Cod. VD007S
481.5x 289 x391.3mm
Weight: 6,8 Kg

INFO



INFO



Grey Aluminum body ●

Black corners ●

OPTIONAL



Model-x Frames
*VARIABLE



Helmet cable
CAV099



Outer Bag 15lt
BI0004



Handles 32/39lt 41/48lt
ASSC006 - ASSC007



Inner Bag 32lt
BI0009 - BI009A



Inner Bag 39lt
BI0010 - BI010A



Inner Bag 41lt
BI0011 - BI011A



Inner Bag 48lt
BI0012 - BI012A

MODEL - X

Valigie laterali
Side suitcase



32 - 39lt

Model-x Small
32 - 39Lt



41 - 48lt

Model-x Large
41 - 48Lt



customize



aluminum



waterproof



lock system



push block

Specifiche tecniche / Technical specifications

SMALL

32lt Cod. VS008A
481.5x 245 x391.3mm
Weight: 6 Kg

39lt Cod. VD008A
481.5x 245 x391.3mm
Weight: 6,3 Kg

INFO

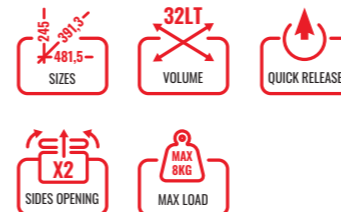

INFO

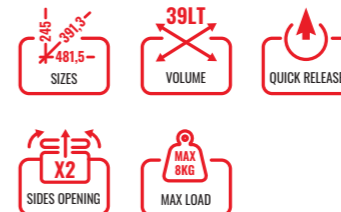

LARGE

41lt Cod. VS007A
481.5x 289 x391.3mm
Weight: 6,5 Kg

48lt Cod. VD007A
481.5x 289 x391.3mm
Weight: 6,8 Kg

INFO

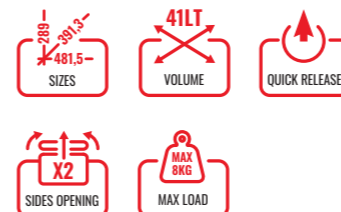

INFO



Black Aluminum body ●

Orange Corners ●

OPTIONAL



Model-x Frames
*VARIABLE



Helmet cable
CAV099



Outer Bag 15lt
BI0004



Handles 32/39lt 41/48lt
ASSC006 - ASSC007



Inner Bag 32lt
BI0009 - BI009A



Inner Bag 39lt
BI0010 - BI010A



Inner Bag 41lt
BI0011 - BI011A



Inner Bag 48lt
BI0012 - BI012A

MODEL - X

Valigie laterali
Side suitcase



32 - 39lt

Model-x Small
32 - 39Lt



41 - 48lt

Model-x Large
41 - 48Lt



customize



aluminum



waterproof



lock system



push block

Specifiche tecniche / Technical specifications

SMALL

32lt Cod. VS08SA
481.5x 245 x391.3mm
Weight: 6 Kg

39lt Cod. VD08SA
481.5x 245 x391.3mm
Weight: 6,3 Kg

INFO

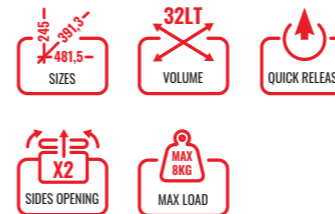

INFO

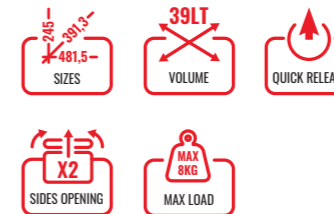

LARGE

41lt Cod. VS07SA
481.5x 289 x391.3mm
Weight: 6,5 Kg

48lt Cod. VD07SA
481.5x 289 x391.3mm
Weight: 6,8 Kg

INFO



INFO



Grey Aluminum body ●

Orange Corners ●

OPTIONAL



Model-x Frames
*VARIABLE



Helmet cable
CAV099



Outer Bag 15lt
BI0004



Handles 32/39lt 41/48lt
ASSC006 - ASSC007



Inner Bag 32lt
BI0009 - BI009A



Inner Bag 39lt
BI0010 - BI010A



Inner Bag 41lt
BI0011 - BI011A



Inner Bag 48lt
BI0012 - BI012A

MODEL - X

Valigie laterali
Side suitcase



32 - 39lt

Model-x Small
32 - 39Lt



41 - 48lt

Model-x Large
41 - 48Lt



customize



aluminum



waterproof



lock system



push block

Specifiche tecniche / Technical specifications

SMALL

32lt Cod.VS008R
481.5x 245 x391.3mm
Weight: 6 Kg

39lt Cod.VD008R
481.5x 245 x391.3mm
Weight: 6,3 Kg

INFO



INFO

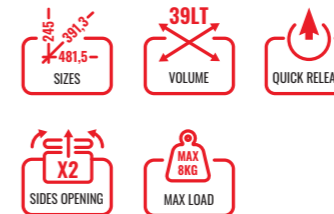

LARGE

41lt Cod. VS007R
481.5x 289 x391.3mm
Weight: 6,5 Kg

48lt Cod. VD007R
481.5x 289 x391.3mm
Weight: 6,8 Kg

INFO



INFO

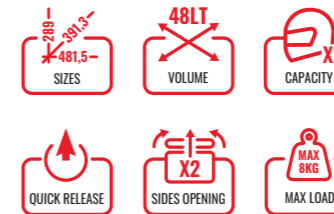

Black Aluminum body ●

Red Corners ●

OPTIONAL



Model-x Frames
*VARIABLE



Helmet cable
CAV099



Outer Bag 15lt
BI0004



Handles 32/39lt 41/48lt
ASSC006 - ASSC007



Inner Bag 32lt
BI0009 - BI009A



Inner Bag 39lt
BI0010 - BI010A



Inner Bag 41lt
BI0011 - BI011A



Inner Bag 48lt
BI0012 - BI012A

MODEL - X

Valigie laterali
Side suitcase



32 - 39lt

Model-x Small
32 - 39Lt



41 - 48lt

Model-x Large
41 - 48Lt



customize



aluminum



waterproof



lock system



push block

Specifiche tecniche / Technical specifications

SMALL

32lt Cod. VS08SR
481.5x 245 x391.3mm
Weight: 6 Kg

39lt Cod. VD08SR
481.5x 245 x391.3mm
Weight: 6,3 Kg

INFO



INFO



LARGE

41lt Cod. VS07SR
481.5x 289 x391.3mm
Weight: 6,5 Kg

48lt Cod. VD07SR
481.5x 289 x391.3mm
Weight: 6,8 Kg

INFO



INFO



Grey Aluminum body ●

Red Corners ●

OPTIONAL



Model-x Frames
*VARIABLE



Helmet cable
CAV099



Outer Bag 15lt
BI0004



Handles 32/39lt 41/48lt
ASSC006 - ASSC007



Inner Bag 32lt
BI0009 - BI009A



Inner Bag 39lt
BI0010 - BI010A



Inner Bag 41lt
BI0011 - BI011A



Inner Bag 48lt
BI0012 - BI012A

MODEL - X

Valigie laterali
Side suitcase



32 - 39lt

Model-x Small
32 - 39Lt



41 - 48lt

Model-x Large
41 - 48Lt



customize



aluminum



waterproof



lock system



push block

Specifiche tecniche / Technical specifications

SMALL

32lt Cod.VS008B
481.5x 245 x391.3mm
Weight: 6 Kg

39lt Cod.VD008B
481.5x 245 x391.3mm
Weight: 6,3 Kg

INFO



INFO



LARGE

41lt Cod. VS007B
481.5x 289 x391.3mm
Weight: 6,5 Kg

48lt Cod. VD007B
481.5x 289 x391.3mm
Weight: 6,8 Kg

INFO



INFO



Black Aluminum body ●

Blue Corners ●

OPTIONAL



Model-x Frames
*VARIABLE



Helmet cable
CAV099



Outer Bag 15lt
BI0004



Handles 32/39lt 41/48lt
ASSC006 - ASSC007



Inner Bag 32lt
BI0009 - BI009A



Inner Bag 39lt
BI0010 - BI010A



Inner Bag 41lt
BI0011 - BI011A



Inner Bag 48lt
BI0012 - BI012A

MODEL - X

Valigie laterali
Side suitcase



32 - 39lt

Model-x Small
32 - 39Lt



41 - 48lt

Model-x Large
41 - 48Lt



customize



aluminum



waterproof



lock system



push block

Specifiche tecniche / Technical specifications

SMALL

32lt Cod. VS08SB
481.5x 245 x391.3mm
Weight: 6 Kg

39lt Cod. VD08SB
481.5x 245 x391.3mm
Weight: 6,3 Kg

INFO



INFO

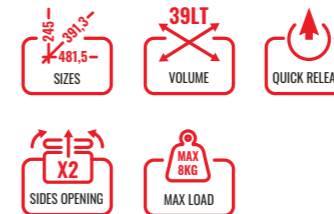

LARGE

41lt Cod. VS07SB
481.5x 289 x391.3mm
Weight: 6,5 Kg

48lt Cod. VD07SB
481.5x 289 x391.3mm
Weight: 6,8 Kg

INFO

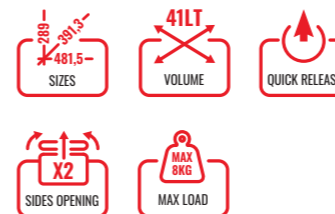

INFO



Grey Aluminum body ●

Blue Corners ●

OPTIONAL ACCESSORI



Model-x Frames
*VARIABLE



Helmet cable
CAV099



Outer Bag 15lt
BI0004



Handles 32/39lt 41/48lt
ASSC006 - ASSC007



Inner Bag 32lt
BI0009 - BI009A



Inner Bag 39lt
BI0010 - BI010A



Inner Bag 41lt
BI0011 - BI011A



Inner Bag 48lt
BI0012 - BI012A



Cavo casco
Helmet cable



Personalizzabili
Customized



Angolari
Corners



SPARE PARTS MODEL - X RICAMBI



Corners 4pz red
ASSC0R



Corners 4pz orange
ASSC0A



Corners 4pz blue
ASSCOB



Corners 4pz black
ASSCON



Hinge red
ASSC10R



Hinge orange
ASSC10A



Hinge blue
ASSC10B



Hinge black
ASSC10N



Handles 33/39lt
ASSC006



Handles 41/47lt
ASSC007



Strap hook
ASSC005



Rotor lock 2pz
ROT002X



Rotor lock 6pz
ROT006X



Rotor lock 9pz
ROT009X



MODEL - X RAW

Valigie laterali
Side suitcase



32 - 39lt

Model-x Raw Small
32 - 39Lt



41 - 48lt

Model-x Raw Large
41 - 48Lt



raw alu



waterproof



lock system



push block

Specifiche tecniche / Technical specifications

SMALL

32lt Cod. VS013G
481.5x 245 x391.3mm
Weight: 6 Kg

39lt Cod. VD013G
481.5x 245 x391.3mm
Weight: 6,3 Kg

INFO

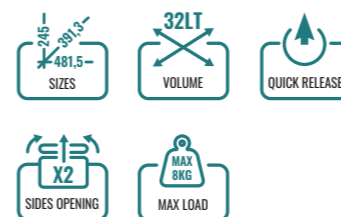

INFO

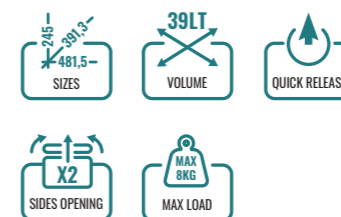

LARGE

41lt Cod. VS012G
481.5x 289 x391.3mm
Weight: 6,5 Kg

48lt Cod. VD012G
481.5x 289 x391.3mm
Weight: 6,8 Kg

INFO

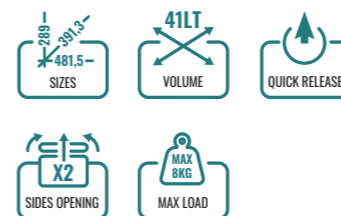

INFO



Raw Aluminum body

OPTIONAL ACCESSORI



Model-x Frames
*VARIABLE



Helmet cable
CAV099



Handles 32/39lt 41/48lt
ASSC006 - ASSC007



Inner Bag 32lt
BI0009 - BI009A



Inner Bag 39lt
BI0010 - BI010A



Inner Bag 41lt
BI0011 - BI011A



Inner Bag 48lt
BI0012 - BI012A



Cavo casco
Helmet cable



Alluminio grezzo
Raw aluminum



Senza angolari
No corners

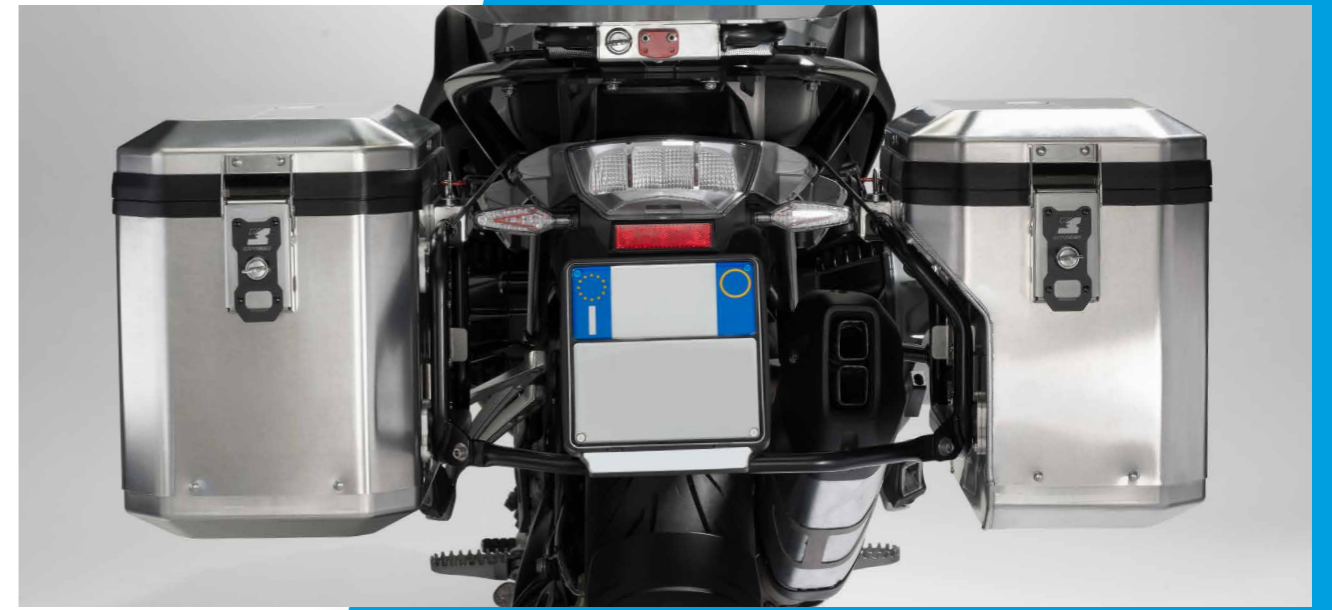

SPARE PARTS MODEL - X RAW RICAMBI



Hinge red
ASSC10R



Hinge orange
ASSC10A



Hinge blue
ASSC10B



Hinge black
ASSC10N



Handles 33/39lt
ASSC006



Handles 41/47lt
ASSC007



Strap hook
ASSC005



Rotor lock 2pz
ROT002X



Rotor lock 6pz
ROT006X



Rotor lock 9pz
ROT009X



MODEL - X GSA

Valigie laterali
Side suitcase



Model-x GSA Raw
41 - 48 Lt



Model-x GSA Black
41 - 48 Lt

41 - 48lt

41 - 48lt



attacks



raw alu



waterproof



lock system



push block

Specifiche tecniche / Technical specifications

RAW

41lt Cod. VSGS07G
481.5x 289 x391.3mm
Weight: 6,5 Kg

48lt Cod. VDGS07G
481.5x 289 x391.3mm
Weight: 6,8 Kg



INFO

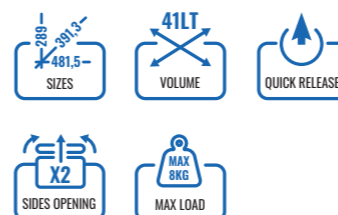

INFO

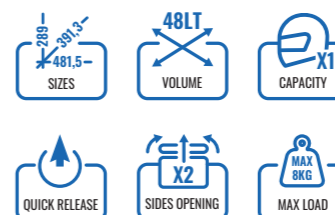

BLACK

41lt Cod. VSGS07
481.5x 289 x391.3mm
Weight: 6,5 Kg

48lt Cod. VDGS07
481.5x 289 x391.3mm
Weight: 6,8 Kg



INFO

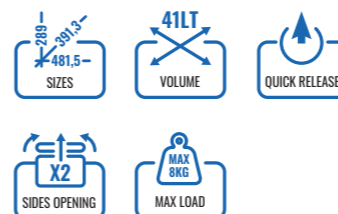

INFO

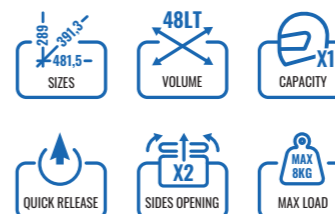

Raw or Black Aluminum body

Black Corners

OPTIONAL ACCESSORI



BMW Original Frames
*VARIABLE



Helmet cable
CAV099



Outer Bag 15lt
BI0004



Handles 41/48lt
ASSC006 - ASSC007



Inner Bag 41lt
BI0011 - BI011A



Inner Bag 48lt
BI0012 - BI012A

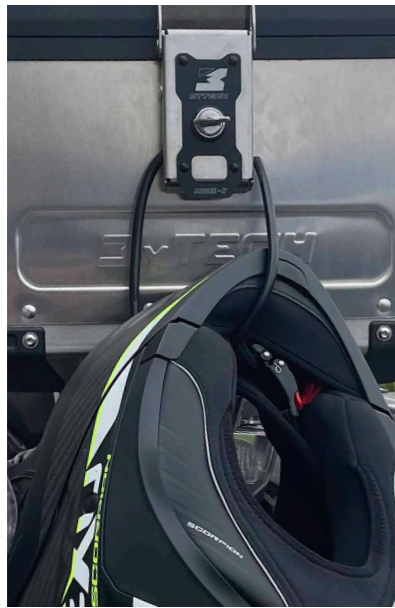

Cavo casco
Helmet cable



Solo per telai originali BMW
Only for original BMW frames



Nere o grezze
Black or raw



SPARE PARTS MODEL - X GSA RICAMBI



Corners 4pz red
ASSCOR



Corners 4pz orange
ASSCOA



Corners 4pz blue
ASSCOB



Corners 4pz black
ASSCON



Hinge red
ASSC10R



Hinge orange
ASSC10A



Hinge blue
ASSC10B



Hinge black
ASSC10N



Handles 41/47lt
ASSC007



Strap hook
ASSC005



Rotor lock 2pz
X2
ROT002X



Rotor lock 6pz
X6
ROT006X



Rotor lock 9pz
X9
ROT009X

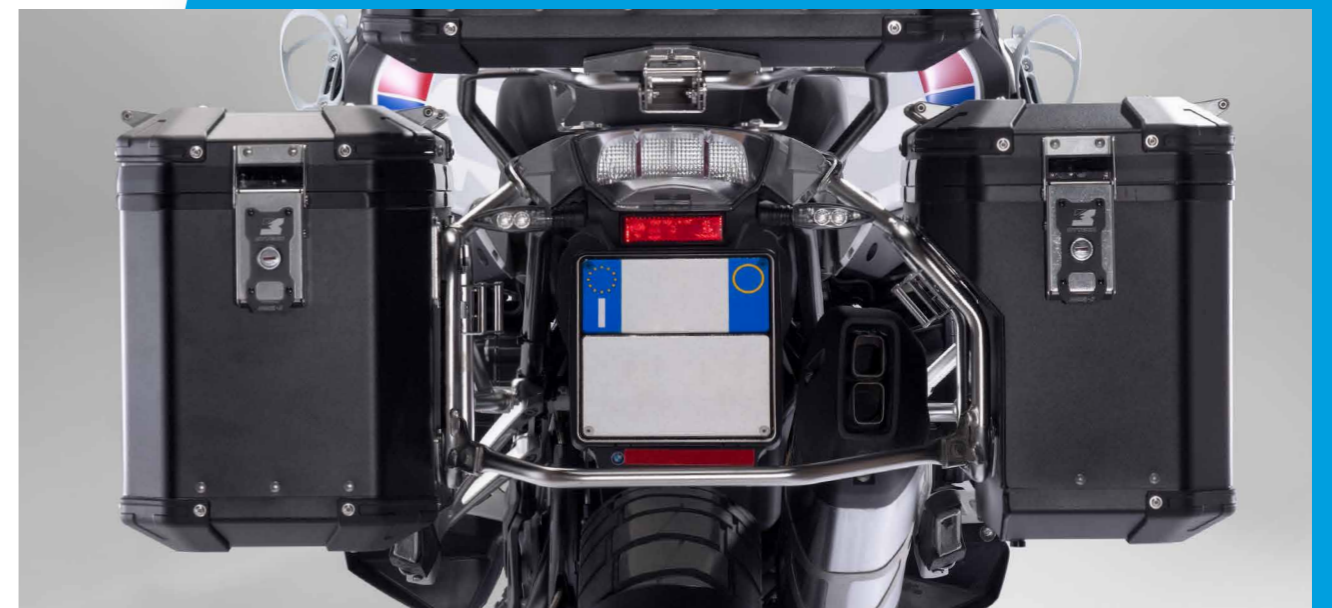

RAID

Valigie laterali
Side suitcase

33 - 39lt



Raid small
33 - 39Lt

41 - 47lt



Raid large
41 - 47 Lt



aluminum



waterproof



lock system



fixed release



quick release

Specifiche tecniche / Technical specifications

SMALL Cod. *next page

33lt
468 x 235 x 380mm
Weight: 6,2 Kg

39lt
468 x 235 x 380mm
Weight: 6,5 Kg



INFO



INFO



LARGE Cod. *next page

41lt
468 x 270 x 400mm
Weight: 6,7 Kg

47lt
468 x 270 x 400mm
Weight: 7 Kg



INFO



INFO



Black Aluminum body ●
Alluminum Corners ●

OPTIONAL



Raid Frames
*VARIABLE



Helmet cable
CAV099



Outer Bag 15lt
BI0004



Handles 33/39lt 41/47lt
ASSC003 - ASSC004



Inner Bag
BI0001



Tool case for panniers
TLC001

Raid SGANCIO FISSO

Specifiche tecniche / Technical specifications

INFO



Black Aluminum body ●

Alluminum Corners ●



39lt Cod. VD0006
Valigia dritta a sinistra
Suitcase straight to the left



33lt Cod. VS0005
Valigia scaricata a destra
Suitcase unloaded on the right

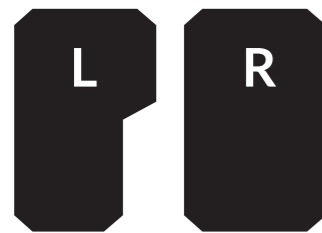

39lt Cod. VD0005
Valigia dritta a destra
Suitcase straight to the right



33lt Cod. VS0006
Valigia scaricata a sinistra
Suitcase unloaded on the left

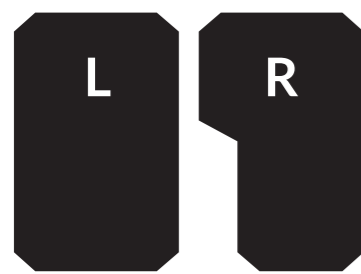

47lt Cod. VD0002
Valigia dritta a sinistra
Suitcase straight to the left



41lt Cod. VS0001
Valigia scaricata a destra
Suitcase unloaded on the right

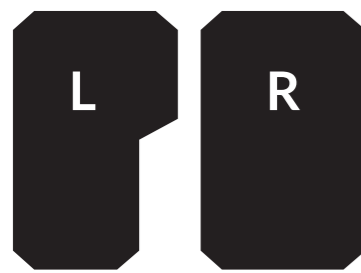

47lt Cod. VD0001
Valigia dritta a destra
Suitcase straight to the right



41lt Cod. VS0002
Valigia scaricata a sinistra
Suitcase unloaded on the left



Raid SGANCIO RAPIDO

Specifiche tecniche / Technical specifications

INFO



Black Aluminum body ●

Alluminum Corners ●



39lt Cod. VD0006R
Valigia dritta a sinistra
Suitcase straight to the left



33lt Cod. VS0005R
Valigia scaricata a destra
Suitcase unloaded on the right



39lt Cod. VD0005R
Valigia dritta a destra
Suitcase straight to the right



33lt Cod. VS0006R
Valigia scaricata a sinistra
Suitcase unloaded on the left



47lt Cod. VD0002R
Valigia dritta a sinistra
Suitcase straight to the left



41lt Cod. VS0001R
Valigia scaricata a destra
Suitcase unloaded on the right

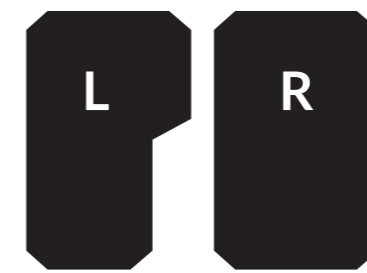

47lt Cod. VD0001R
Valigia dritta a destra
Suitcase straight to the right



41lt Cod. VS0002R
Valigia scaricata a sinistra
Suitcase unloaded on the left



RAID

Valigie laterali
Side suitcase



33 - 39lt

Raid small
33 - 39Lt



41 - 47lt

Raid large
41 - 47 Lt



aluminum



waterproof



lock system



fixed release



quick release

Specifiche tecniche / Technical specifications

SMALL Cod. *next page

33lt
468 x 235 x 380mm
Weight: 6,2 Kg

39lt
468 x 235 x 380mm
Weight: 6,5 Kg



INFO

- SIZES: 235-380 / 468
- VOLUME: 33LT
- QUICK RELEASE
- FIXED RELEASE
- SIDES OPENING: X2
- MAX LOAD: MAX 8KG

INFO

- SIZES: 235-380 / 468
- VOLUME: 39LT
- QUICK RELEASE
- FIXED RELEASE
- SIDES OPENING: X2
- MAX LOAD: MAX 8KG

LARGE Cod. *next page

41lt
468 x 270 x 400mm
Weight: 6,7 Kg

47lt
468 x 270 x 400mm
Weight: 7 Kg



INFO

- SIZES: 270-400 / 468
- VOLUME: 41LT
- QUICK RELEASE
- FIXED RELEASE
- SIDES OPENING: X2
- MAX LOAD: MAX 8KG

INFO

- SIZES: 270-400 / 468
- VOLUME: 47LT
- CAPACITY: X1
- QUICK RELEASE
- FIXED RELEASE
- SIDES OPENING: X2

INFO

- MAX LOAD: MAX 8KG

Grey Aluminum body ●

Alluminum Corners ●

OPTIONAL



Raid Frames
*VARIABLE



Helmet cable
CAV099



Outer Bag 15lt
BI0004



Handles 33/39lt 41/47lt
ASSC003 - ASSC004



Inner Bag
BI0001



Tool case for panniers
TLC001

Raid SGANCIO FISSO

Specifiche tecniche / Technical specifications

INFO



Grey Aluminum body ●

Alluminum Corners ●



39lt Cod. VD0006S
Valigia dritta a sinistra
Suitcase straight to the left



33lt Cod. VS0005S
Valigia scaricata a destra
Suitcase unloaded on the right

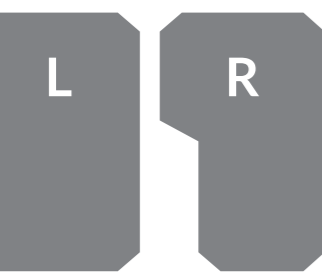

39lt Cod. VD0005S
Valigia dritta a destra
Suitcase straight to the right



33lt Cod. VS0006S
Valigia scaricata a sinistra
Suitcase unloaded on the left



Raid SGANCIO RAPIDO

Specifiche tecniche / Technical specifications

INFO



Grey Aluminum body ●

Alluminum Corners ●



39lt Cod. VD006RS
Valigia dritta a sinistra
Suitcase straight to the left



33lt Cod. VS005RS
Valigia scaricata a destra
Suitcase unloaded on the right

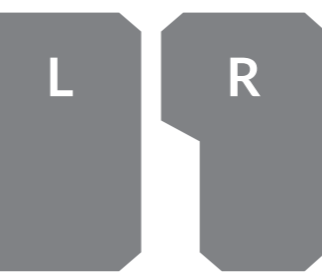

39lt Cod. VD005RS
Valigia dritta a destra
Suitcase straight to the right



33lt Cod. VS006RS
Valigia scaricata a sinistra
Suitcase unloaded on the left



47lt Cod. VD002RS
Valigia dritta a sinistra
Suitcase straight to the left



41lt Cod. VS001RS
Valigia scaricata a destra
Suitcase unloaded on the right



47lt Cod. VD0001RS
Valigia dritta a destra
Suitcase straight to the right

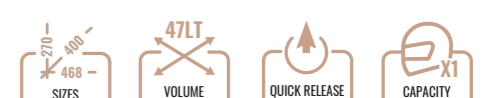

41lt Cod. VS0002RS
Valigia scaricata a sinistra
Suitcase unloaded on the left



RAID

Valigie laterali
Side suitcase



39 - 39lt

Raid small
39 - 39Lt



47 - 47lt

Raid large
47 - 47 Lt



aluminum



waterproof



lock system



fixed release



quick release

Specifiche tecniche / Technical specifications

SMALL

Cod. *next page



39lt

468 x 235 x 380mm
Weight: 6,5Kg



39lt

468 x 235 x 380mm
Weight: 6,5 Kg



INFO



INFO



LARGE

Cod. *next page



47lt

468 x 270 x 400mm
Weight: 7 Kg



47lt

468 x 270 x 400mm
Weight: 7Kg



INFO



INFO



Black Aluminum body ●

Alluminum Corners ●

OPTIONAL



Raid Frames

*VARIABLE



Helmet cable

CAV099



Outer Bag 15lt

BI0004



Handles 33/39lt 41/47lt

ASSC003 - ASSC004



Inner Bag

BI0001



Tool case for panniers

TLC001

Raid SGANCIO FISSO

Specifiche tecniche / Technical specifications

INFO



Black Aluminum body ●

Alluminum Corners ●



L **39lt** Cod. VD0006
Valigia dritta a sinistra
Suitcase straight to the left



R **39lt** Cod. VD0005
Valigia dritta a destra
Suitcase straight to the right



L **47lt** Cod. VD0002
Valigia dritta a sinistra
Suitcase straight to the left



R **47lt** Cod. VD0001
Valigia dritta a destra
Suitcase straight to the right



Raid SGANCIO RAPIDO

Specifiche tecniche / Technical specifications

INFO



Black Aluminum body ●

Alluminum Corners ●



L **39lt** Cod. VD0006R
Valigia dritta a sinistra
Suitcase straight to the left



R **39lt** Cod. VD0005R
Valigia dritta a destra
Suitcase straight to the right



L **47lt** Cod. VD0002R
Valigia dritta a sinistra
Suitcase straight to the left



R **47lt** Cod. VD0001R
Valigia dritta a destra
Suitcase straight to the right

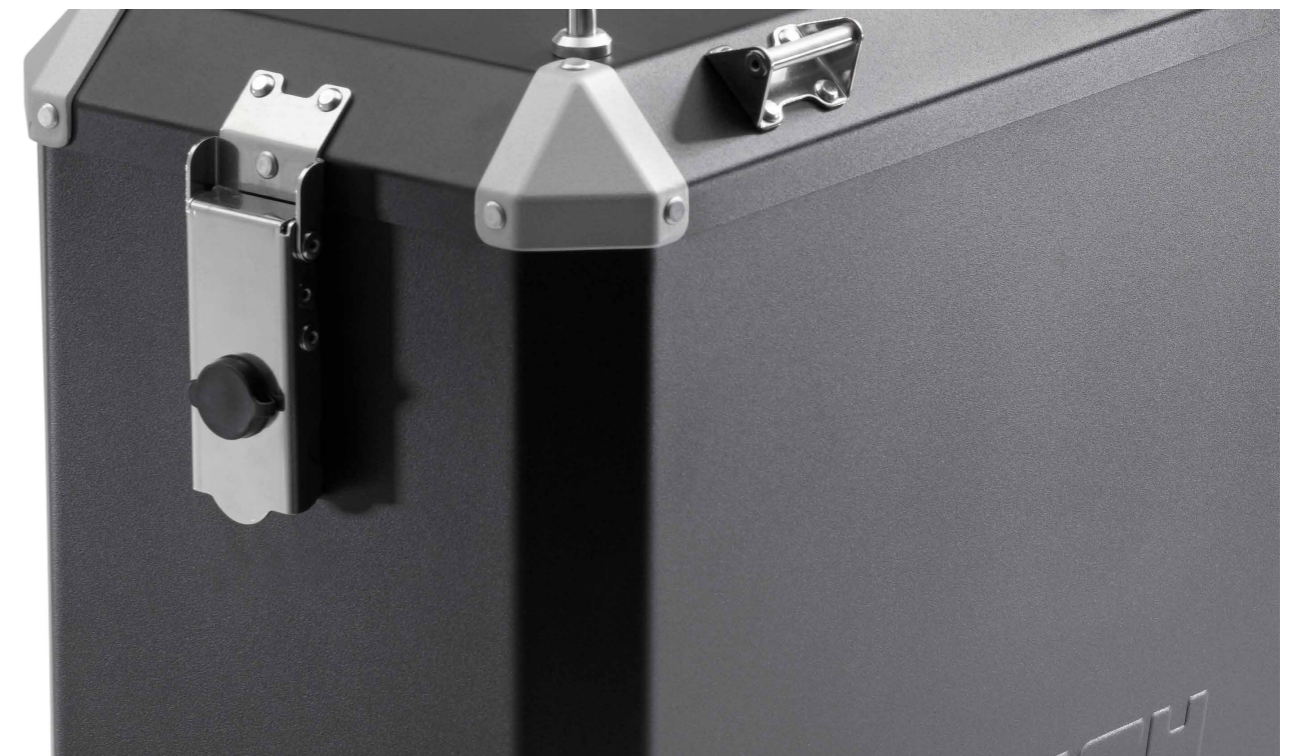

RAID

Valigie laterali
Side suitcase



Raid small
39 - 39Lt

39 - 39lt



Raid large
47 - 47 Lt

47 - 47lt



aluminum



waterproof



lock system



fixed release



quick release

Specifiche tecniche / Technical specifications

SMALL Cod. *next page

39lt
468 x 235 x 380mm
Weight: 6,5 Kg

39lt
468 x 235 x 380mm
Weight: 6,5 Kg



INFO



INFO



LARGE Cod. *next page

47lt
468 x 270 x 400mm
Weight: 7 Kg

47lt
468 x 270 x 400mm
Weight: 7 Kg



INFO



INFO



Grey Aluminum body ●

Alluminum Corners ●

OPTIONAL ACCESSORI



Raid Frames
*VARIABLE



Helmet cable
CAV099



Outer Bag 15lt
BI0004



Handles 33/39lt 41/47lt
ASSC003 - ASSC004



Inner Bag
BI0001



Tool case for panniers
TLC001 - TLC001S



Tank and Tank Holder
BMW413 - TNK200

Raid SGANCIO FISSO

Specifiche tecniche / Technical specifications

INFO



Grey Aluminum body ●

Alluminum Corners ●



L **39lt** Cod. VD0006S
Valigia dritta a sinistra
Suitcase straight to the left



R **39lt** Cod. VD0005S
Valigia dritta a destra
Suitcase straight to the right



L **47lt** Cod. VD0002S
Valigia dritta a sinistra
Suitcase straight to the left



R **47lt** Cod. VD0001S
Valigia dritta a destra
Suitcase straight to the right



Raid SGANCIO RAPIDO

Specifiche tecniche / Technical specifications

INFO



Grey Aluminum body ●

Alluminum Corners ●



L **39lt** Cod. VD006RS
Valigia dritta a sinistra
Suitcase straight to the left



R **39lt** Cod. VD005RS
Valigia dritta a destra
Suitcase straight to the right



L **47lt** Cod. VD002RS
Valigia dritta a sinistra
Suitcase straight to the left



R **47lt** Cod. VD0001RS
Valigia dritta a destra
Suitcase straight to the right





Cavo casco
Helmet cable



Porta attrezzi per valigia
Tool Case for Pannier



Tanica e porta tanica
Tank



SPARE PARTS Raid RICAMBI



Hinge
ASSC001



Strap hook
ASSC002



Handles 33/39lt
ASSC003



Handles 41/47lt
ASSC004



Rotor lock 1pz
ROT495R



Rotor lock 2pz
ROT195R



Rotor lock 4pz
ROT295R



Rotor lock 6pz
ROT695R



Rotor lock 7pz
ROT795R



RAID GSA

Valigie laterali
Side suitcase



41 - 47lt

Raid GSA
41 - 47Lt



41 - 47lt

Raid GSA
41 - 47Lt



attacks



aluminum



waterproof



lock system



quick release

Specifiche tecniche / Technical specifications

BLACK

41lt Cod. VS0GS1R
468 x 270 x 400mm
Weight: 6,7 Kg

47lt Cod. VD0GS1R
468 x 270 x 400mm
Weight: 7 Kg



INFO



INFO



SILVER Cod. * next page

41lt Cod. VS0GS1RS
468 x 270 x 400mm
Weight: 6,7 Kg

47lt Cod. VD0GS1RS
468 x 270 x 400mm
Weight: 7 Kg



INFO



INFO



Black or grey Aluminum body

Alluminum Corners

OPTIONAL ACCESSORI



BMW Original Frames
*VARIABLE



Helmet cable
CAV099



Outer Bag 15lt
BI0004



Handles 41/47lt
ASSC004



Inner Bag
BI0001



Tool case for panniers
TLC001



Cavo casco
Helmet cable



Porta attrezzi per valigia
Tool Case for Pannier



Tanica e porta tanica
Tank



SPARE PARTSraid RICAMBI

 Hinge ASSC001	 Strap hook ASSC002	 Handles 41/47lt ASSC004	 Rotor lock 1pz ROT495R
 Rotor lock 2pz ROT195R	 Rotor lock 4pz ROT295R	 Rotor lock 6pz ROT695R	 Rotor lock 7pz ROT795R

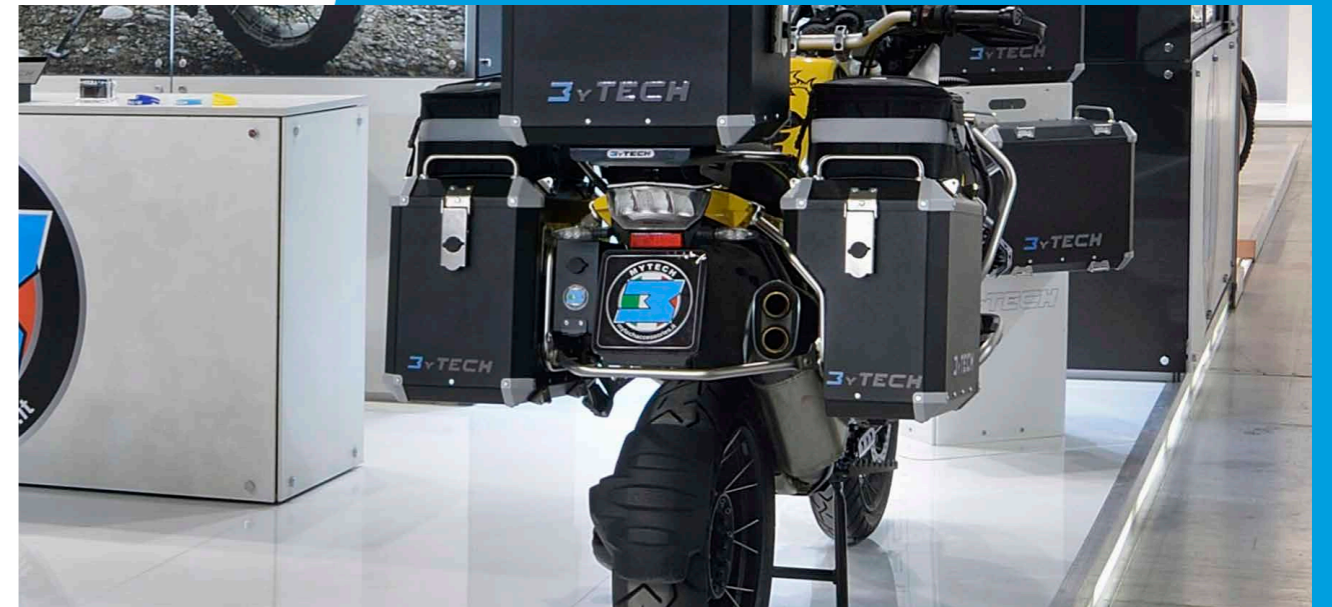

SMART TANK

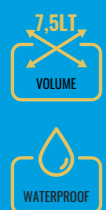

7,5lt

Valigia Smart Tank

Cod * Variable



Black ●

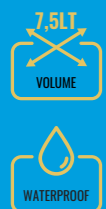

7,5lt

Valigia Smart Tank

Cod * Variable



Blue ●



aluminum



waterproof



lock system



fixed release



7,5lt

Valigia Smart Tank

Cod * Variable



Gold ●



7,5lt

Valigia Smart Tank

Cod * Variable



Red ●



7,5lt

Valigia Smart Tank

Cod * Variable



White ○



12lt

Valigia Smart Tank

Cod * Variable



Black ●



12lt

Valigia Smart Tank

Cod * Variable



Red ●



12lt

Valigia Smart Tank

Cod * Variable

Blue ●



12lt

Valigia Smart Tank

Cod * Variable

White ○



12lt

Valigia Smart Tank

Cod * Variable



Gold ●

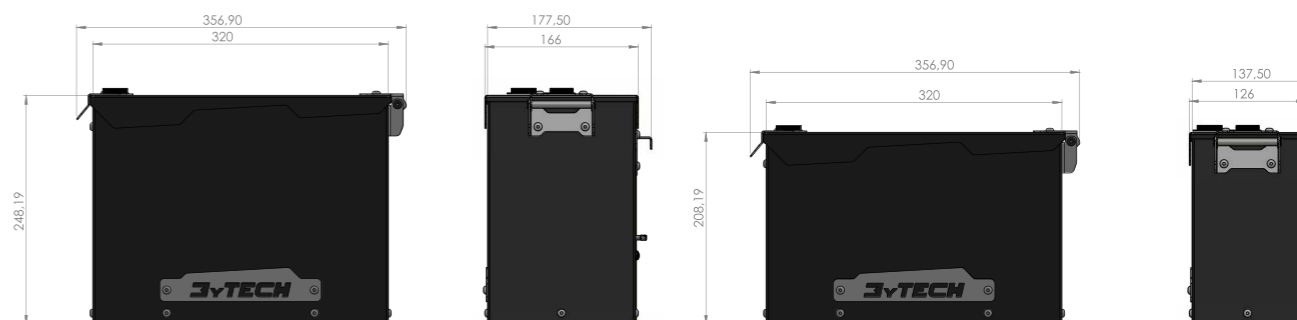

12lt

7,5lt